

SPECIFICATION	CONNECTION	UNIPOLAR	BIPOLAR (SERIAL)	BIPOLAR (PARALLEL)
VOTAGE(VOC)		3.90	5.50	2.70
AMPS/PHASE		3.00	2.10	4.20
RESISTANCE/PHASE(Ohms)@25°C		1.30±10%	2.60±10%	0.65±10%
INDUCTANCE/PHASE(mH)@1KHz		3.20±20%	12.80±20%	3.20±20%
HOLDING TORQUE(Nm)[lb-in]		2.20[19.47]	3.10[27.44]	3.10[27.44]
STEP ANGLE(°)		1.80		
STEP ACCURACY(NON-ACCUM)		±5.00%		
ROTOR INERTIA(g-cm ²)		840.00		
WEIGHT(Kg)[lb]		1.34[2.95]		
TEMPERATURE RISE:MAX.80°C (MOTOR STANDSTILL;FOR 2PHASE ENERGIZED)				
AMBIENT TEMPERATURE -10°C~50°C[14°F~122°F]				
INSULATION RESISTANCE 100 Mohm (UNDER NORMAL TEMPERATURE AND HUMIDITY)				
INSULATION CLASS B 130°C[266°F]				
DIELECTRIC STRENGTH 500VAC FOR 1MIN.(BETWEEN THE MOTOR COILS AND THE MOTOR CASE)				
AMBIENT HUMIDITY MAX.85%(NO CONDENSATION)				

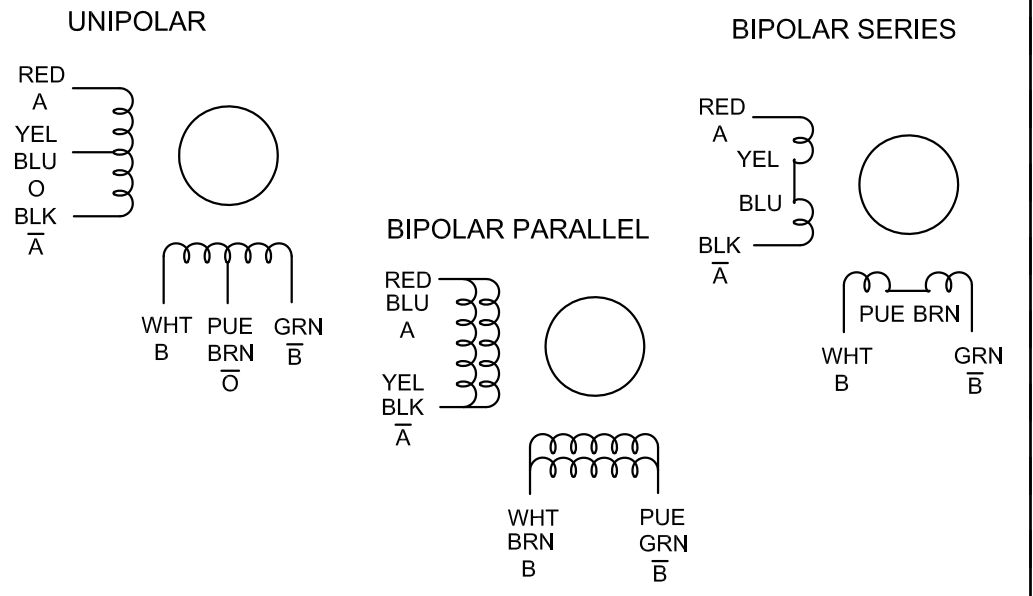

APVD		
CHKD		
1:1.5	DRN	
SCALE	SIGNATURE	DATE

STEPPER MOTOR

24HS34-3008D