

SPECIFICATION	VALUE
NO. of PHASES	3
NO. of POLES	4
RATED VOLTAGE(V)	36
RATED CURRENT(A)	7.3±10%
RATED POWER(W)	184
RATED SPEED(RPM)	4000±10%
RATED TORQUE(mN.m)	440
HALL LEAD STYLE	UL 1007 AWG26
PHASE LEAD STYLE	UL 1007 AWG18
SENSOR	HALL SENSOR
INSULATION CLASS	CLASS B
INSULATION RESISTANCE	100MΩ MIN @ 500VDC
DIELECTRIC STRENGTH TEST	500VAC for 1 MINUTE
BEARING TYPE	NMB BALL BEARING, C3

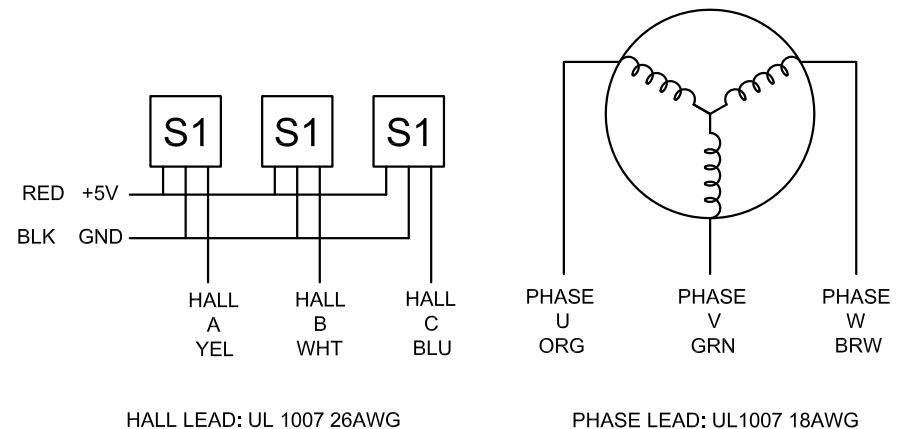

APVD		
CHKD		
1.5:1	DRN	
SCALE	SIGNATURE	DATE

BRUSHLESS DC MOTOR

57BLR110-36-01