

SPECIFICATION	VALUE
NO. of PHASES	3
NO. of POLES	4
RATED VOLTAGE(V)	36
RATED CURRENT(A)	1±10%
RATED POWER(W)	25
RATED SPEED(RPM)	4400±10%
RATED TORQUE(mN.m)	55
HALL LEAD STYLE	UL 1007 AWG26
PHASE LEAD STYLE	UL 1007 AWG22
SENSOR	HALL SENSOR
INSULATION CLASS	CLASS B
INSULATION RESISTANCE	100MΩ MIN @ 500VDC
DIELECTRIC STRENGTH TEST	500VAC for 1 MINUTE
BEARING TYPE	NMB BALL BERRING, C3

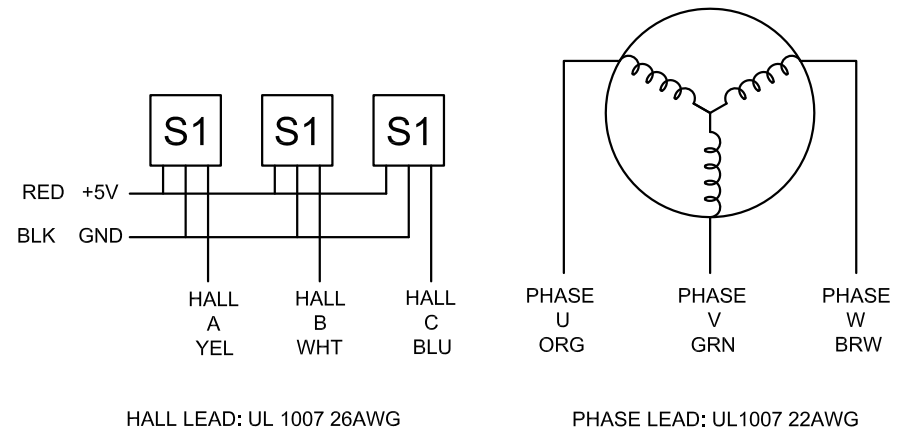

	APVD		
	CHKD		
1.5:1	DRN		
SCALE	SIGNATURE	DATE	

BRUSHLESS DC MOTOR

57BLR43-36-01