

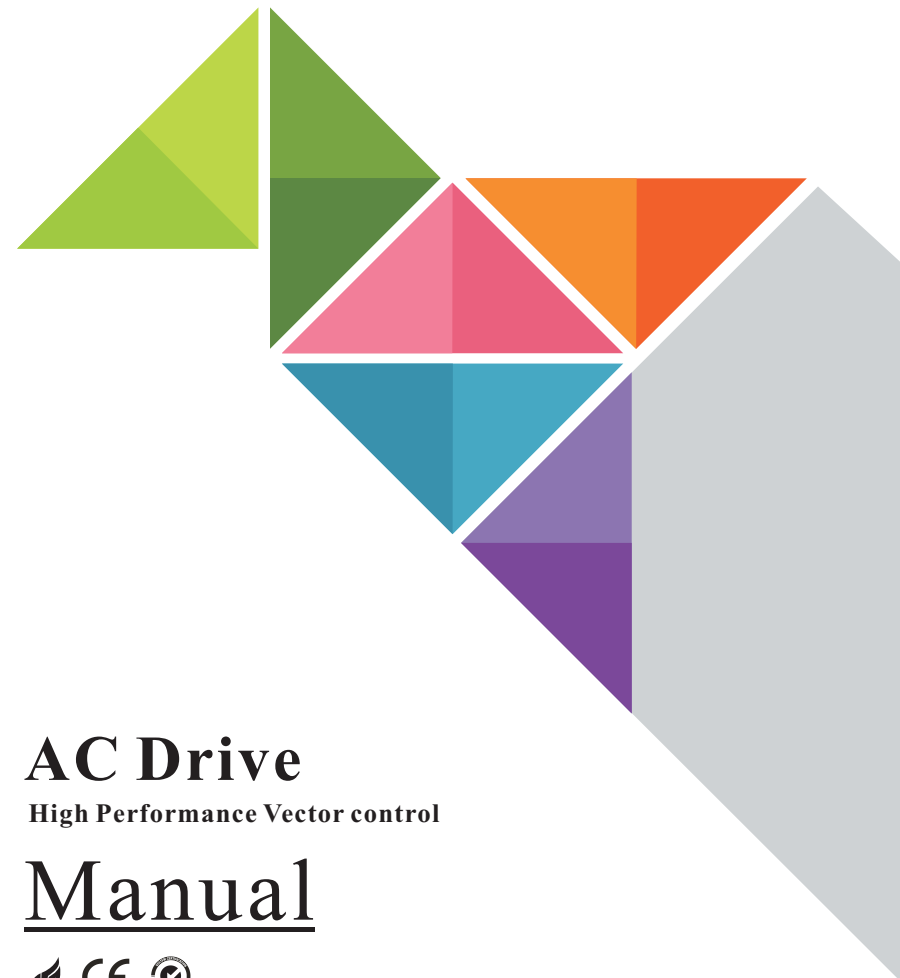

www.oyostepper.com



AC Drive

High Performance Vector control

Manual



www.oyostepper.com

Preface

Thanks for choosing the high performance general purpose AC drive AC drives are general type inverters with vector control .High quality, multiple functions and low noise, developed independently by ourselves. It can realize open loop and close loop control of different mode,and also signal detection of PT100/PT1000 motor temperature.It support speed sensorless vector control,sensor vector control and V/F control.Performance of motor control has been improved obviously.Easy operation,perfect self-learning of motor static and dynamic state.

AC drives are compact structure, easy installation, and reasonable heat dissipation design ,that ensure reliability of product. Various of expansion cards are available for your choice.

We provide information of model selection, installation, parameter setting, field debugging, fault diagnosis and daily maintenance for users in this manual.

First use:

For those users who use this product for the first time, they shall carefully read this manual first. If you have any problems in some functions and usability, please seek technical support to us.



www.oyostepper.com

Attentions:

- ◆ Please power off when wiring.
- ◆ Electronic components inside AC drive are especially sensitive to static electricity, do not put anything into internal of AC drive.And do not touch main circuit board.
- ◆ After power cut, if indicator is still lamp, it still have high voltage in AC drive. It is very dangerous, please do not touch internal circuit and components.
- ◆ Please ensure the grounding terminals of AC drive \oplus is grounded correctly.
- ◆ Never connect input power supply with output terminal U,V,W of AC drive.

www.oyostepper.com

Catalogue

Chapter 1	Safety and Attentions	1
Chapter 2	Product Brief Introduction	6
Chapter 3	Installation	12
Chapter 4	Operation and Display	22
Chapter 5	Function & Parameter Table	27
Chapter 6	Description of Function Codes	64
	Group F00: Standard Function Parameters	64
	Group F01: Start-stop Control Parameters	74
	Group F02: Motor 1 Parameters	78
	Group F03: Vector Control Parameters	81
	Group F04: V/F Control Parameters	85
	Group F05: Input Terminals	90
	Group F06: Output Terminals	101
	Group F07: Keypad And Display	107
	Group F08: Auxiliary Functions	111
	Group F09: Fault and Protection	123
	Group F10: Process Control PID Function	132
	Group F11: Swing Frequency, Fixed Length and Count	138
	Group F12: Simple PLC Function And Multi-speed control	140
	Group F13: Communication Parameters	144
	Group F15: Motor 2 Parameters	146

Catalogue

Chapter 7	Common Faults and Solutions	147
Chapter 8	Warranty Agreement	154
Appendix A	Serial Communications	155
Appendix B	External Dimension	165
Appendix C	Accessories Selection	167
Appendix D	Using Introduction of I/O extension card	170
Appendix E	Using Introduction of PG card	171

Chapter 1 Safety and Attentions

Definition of Safety:

In this manual, safety precautions will be presented as following two categories:

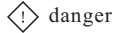
 **danger** Dangers caused by operations beyond requirements may lead to serious injury, and even death.

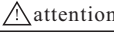
 **attention** Dangers caused by operations beyond requirements may lead to moderate damages or minor injuries, as well as equipment damages.

1.1 Safety Matters

I. Before installing:

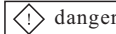
 **danger**

Please do not use damaged and shot-part drives. There are risks of being hurt.

II. In installation:

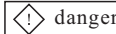
 **danger**

Please install it on metal and other inflammable retarding objects: to keep away from combustible, or it may give rise to fire alarm!

 **attention**

- ★ More than two AC drives shall be placed in a same cabinet. Please pay attention to the installation site (refer to Installation in Chapter 3) and guarantee heat dissipation effects.
- ★ Wires or bolts shall not fall into AC drive, or it will lead to the damages of AC drive!

III. In wiring

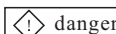
 **danger**

- ★ It shall be constructed by professional electric engineering personnel, or it will give rise to electric shock hazard!
- ★ AC drive and power supply shall be separated by breaker, or it will cause fire alarm!
- ★ Before wiring, please confirm power off, or it will cause electric shock hazard!
- ★ Please make ground connection as standard requests, or it will cause electric shock hazard!

 **attention**

- ★ The input power line cannot be connected to output end, U, V, W, or it will damage AC drive!
- ★ Please confirm the equipped wires will accord with EMC requirements and regional safety standards. For the adopted wire diameter, please refer to the suggestions in manual, or it will lead to accidents!
- ★ Brake resistor cannot be connected directly to the two ends of DC bus (+) and terminal(-), or it will cause fire alarm!

IV. Before power on

 **attention**

- ★ Please confirm whether supply voltage class is in accord with the nominal voltage of AC drive: whether connection location of input and output is correct, and pay attention to check whether short circuit phenomenon exists in peripheral circuit and whether the connected circuit is tight, or they will cause damages to AC drive!
- ★ Power on is permissible only AC drive is covered with plate, or it will give rise to an electric shock!

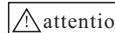
 **attention**

- ★ Pressure-tight test is not necessary for AC drive, and the product has been made relevant test before leaving factory, or it will give rise to accidents!
- ★ Confirm whether all peripheral equipments have been connected correctly as the circuits provided in this manual, or it may give rise to accidents!

V. After power on

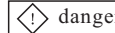
 **danger**

- ★ Please do not open the cover plate after power on, or it will give rise to electric shock hazard!
- ★ Do not touch AC drive and peripheral circuit with wet hands, or it will give rise to electric shock hazard!
- ★ Do not touch AC drive terminal, or it will give rise to electric shock hazard!
- ★ After power on, AC drive will make security detection over external strong electricity circuit. For the time being, please do not touch U, V and W connection terminal or motor connection terminal of the AC drive, or it will give rise to electric shock hazard!

 attention
<ul style="list-style-type: none"> ★ If you need to make parameter identification, please pay attention to the hurting dangers while motor is rotating, or it will give rise to accidents! ★ Please do not change manufacturer parameters of AC drive at will, or it will cause damages to equipment!

VI. In service

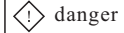
 danger
<ul style="list-style-type: none"> ★ If you select restart function, please do not get close to mechanical equipment, or it will give rise to personal injury! ★ Please do not touch cooling fan and discharge resistance to sense temperature, or it will give rise to burn! ★ Non-professional technicians shall not detect signal in service, or it will give rise to personal injuries or equipment troubles!

 attention
<ul style="list-style-type: none"> ★ When AC drive is in service, anything shall be avoided falling into equipment, or it will cause damages to equipment! ★ Please do not try to control start-stop of AC drive, or it will cause damages to equipment!

VII. In maintenance:

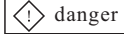
 danger
<ul style="list-style-type: none"> ★ Please do not make repair and maintenance over equipment in a charged state, or it will give rise to electric shock hazard! ★ AC drive can be put into maintenance and repair only you confirm the AC drive charge light out, or the remaining electric charge of capacitance will cause damages to people! ★ Any people who are not trained professionally cannot make repair and maintenance, or it will cause personal injuries or equipment troubles!

1. 2 Attentions

I. Motor insulation inspection

When motors are used for the first time, reused after a long-time placement, and in regular checking, insulation inspection is necessary first to prevent damaging AC drive from the insulation failure of motor winding. In insulation inspection, motor connection wires shall be separated from AC drive. 500V voltage type tramegger is recommended to guarantee the measured insulation resistance shall not less than 5MΩ.

II. Motor thermal protection

If the selected motor mismatches with rated capacity of AC drive, especially rated power of AC drive is larger than that of motor, please adjust parameter values related to motor protection inside AC drive, or heat relay to protect motor.

III. Power frequency operation

This AC drive can provide 0~600Hz output frequency. If you need to operate it over 50Hz, please consider tolerance of mechanical device.

IV. About motor heating and noise

As output voltage of AC drive is PWM wave with definite harmonic waves, compared with power frequency operation, temperature rise, noise and vibration of motor increase more or less.

V. Capacitive condition of outlet side with pressure-sensitive devices or ameliorative power factor

Output of AC drive is PWM wave. If capacitance or piezoresistor for thunder prevention with improving power factors is installed at outlet side, it is easy to cause momentary overcurrent of AC drive and even cause damages to AC drive. Please do not use it.

VI. Contactor and other switching elements applied in input and output terminals of AC drive

When you install contactor between power supply and input terminal of AC drive, please do not try to control start-stop of AC drive with this contactor. If you have to do this, please ensure the interval will not be less than one hour. Frequent charge-discharge operations will easily shorten service life of capacitor inside the AC drive. If contactor and other switching elements are installed between output terminal and motor, you shall guarantee make-break operation is processed when AC drive has no output, or it will cause module damages inside the AC drive easily.

VII. Application except nominal voltage values

AC drive are not appropriate to be applied beyond allowable operating voltage range required in this manual, or it will cause damages to components inside the AC drives. If needed, please make voltage transformation treatment with corresponding boosting or dropping equipment.

VIII. Change three-phase input to one-phase input

For those types without marks of one-phase input in AC drive, one-phase input is not allowed to be adopted, or it will cause damages to AC drives.

IX. Lightning impulse protection

Lightning stroke over-current protection device is installed in this series of AC drives, and has self-defensive ability over inductive thunder. For some areas with frequent thunder, clients shall install protection devices at front end of AC drive.

X. Elevation and derating use

In those areas with over 1000m elevation, rarefied air causes a bad heat dissipation effect of AC drive, and so derating use is necessary. About this circumstance, please seek for technology consulting from our company.

XI. Some special usages

If clients need the methods beyond the suggested wiring diagrams provided in this manual in use, such as DC bus, please consult our company.

XII. Attentions of AC drive scrapping

When electrolytic capacitor of major circuit and electrolytic capacitor on printed board are incinerated, explosion may happen. And the incineration of plastic components will generate poisonous gas. Please dispose them as industrial refuse.

XIII. About adaptive motor

1. Standard adaptive motor is quadrupole squirrel-cage asynchronous induction motor. If it is not above-mentioned motor, please select AC drive upon rated current of motor. If you need to drive permanent magnet synchronous motor, please consult our company;

2. The cooling fan of non variable frequency motor and rotor spindle are coaxially connected. While despinning, the fan cooling effect also declines at the same time. Hence, for overheated occasion of motor, you shall install strong exhaust fan or change variable frequency motor;

3. AC drives have built-in adaptive motor standard parameters. It is necessary to make motor parameter identification or amend default values to accord with actual values, or it will influence operation effects and protective values;

4. As short circuit existing inside cable or motor will cause inverter alarming, even explosion. Therefore, please make insulation short-circuit test of initial installed motor and cable first. And the test also is necessary in routine maintenance.

Attention: Before test, please break AC drive and all tested parts first.

Chapter 2 Product Brief Introduction

2.1 Attentions of arrival inspection · Storage

Before leaving factory, these products all have been made strict quality testing, as well as collision avoidance, quake proof measure and other packaging treatments. But in transit, carrying or severe impact will cause damages to products. So after unpacking, please take following inspection items at once:

● Inspection before unpacking

Confirm whether damages are caused in transportation process.

● Inspection after unpacking

Check whether damages are caused in transportation process; whether the specifications and models on nameplate are in accord with your requirements, and whether service manual and other accessories are all in readiness. If you find any damage or discrepancies, please contact with supplier for solution without delay.

● Storage

Before installation, this product shall be placed inside the packing carton. If the machine will not be used temporarily, for this machine can accord with warranty conditions and future maintenance of our company, so in storage, please pay attention to following items:

1. Placed in a dry environment without dusts and dirt.
2. The temperature of storage environment shall be controlled between -20°C to $+65^{\circ}\text{C}$.
3. The relative humidity of storage environment shall be controlled within the scope of 0% to 95%, and without moisture condensation.
4. Avoid being storage in the environment with corrosive gas and liquid.
5. It will be better to package it properly and place it on shelf or table board.

● Transportation

In transportation process, it shall be kept in accord with following conditions:

1. The temperature shall be kept from -25°C to $+70^{\circ}\text{C}$.
2. Relative humidity shall be kept from 5% to 95%.
3. Barometric pressure must be maintained from 70kPa to 106kPa.

2.2 AC drive nameplate and specifications:

● AC drive nameplate:

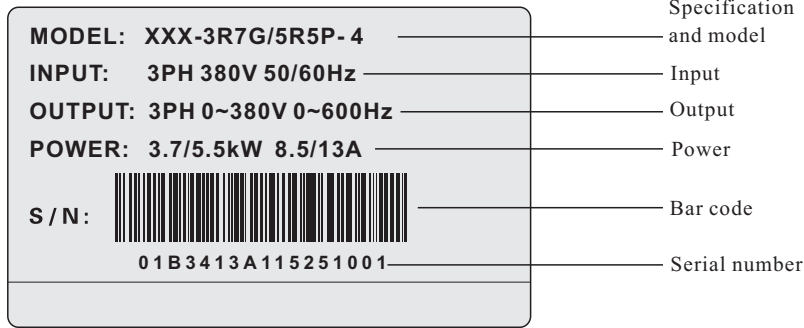

● Specifications and models:

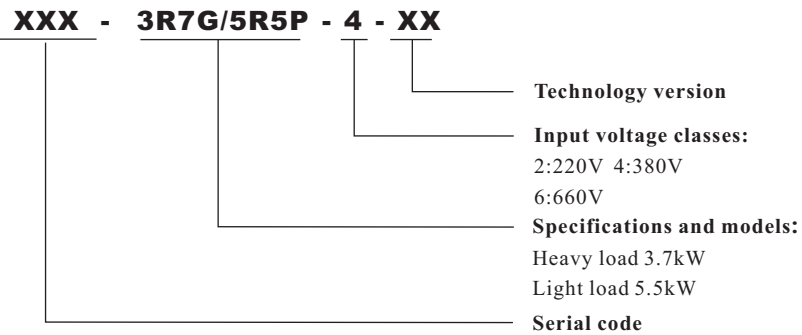

● Production code:

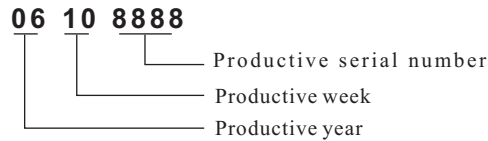

2.3 Specifications and models of AC drives

Rated power (kW)	Rated input current (A)	Rated output current (A)	Adaptive motor (kW)
3PH 220V ±15% 47Hz ~ 63Hz			
0.55	3.8	3.2	0.55
0.75	4.9	4.1	0.75
1.5	8.4	7.0	1.5
2.2	11.5	10.0	2.2
3.7	18	15	3.7
5.5	24	23	5.5
7.5	37	31	7.5
11	52	45	11
15	68	58	15
18	84	71	18
22	94	85	22
30	120	115	30
37	160	145	37
45	198	180	45
55	237	215	55
75	317	283	75

Rated power (kW)	Rated input current (A)	Rated output current (A)	Adaptive motor (kW)
Input 3PH 380V±15% 47Hz~63Hz			
0.75/1.5	3.4/5.0	2.5/3.7	0.75/1.5
1.5/2.2	5.0/5.8	3.7/5.0	1.5/2.2
2.2/3.7	5.8/10.5	5.0/8.5	2.2/3.7
3.7/5.5	10.5/14.6	8.5/13	3.7/5.5
5.5/7.5	14.6/20.5	13/18	5.5/7.5
7.5/11	20.5/26	18/24	7.5/11
11/15	26/35	24/30	11/15
15/18.5	35/38.5	30/37	15/18.5
18.5/22	38.5/46.5	37/46	18.5/22
22/30	46.5/62	46/58	22/30
30/37	62/76	58/75	30/37
37/45	76/92	75/90	37/45
45/55	92/113	90/110	45/55
55/75	113/157	110/150	55/75
75/93	157/180	150/170	75/93
93/110	180/214	170/210	93/110
110/132	214/256	210/250	110/132
132/160	256/307	250/300	132/160
160/200	307/385	300/380	160/200
200/220	385/430	380/430	200/220
220/250	430/468	430/465	220/250
250/280	468/525	465/520	250/280
280/315	525/590	520/585	280/315
315/350	590/665	585/650	315/350
350/400	665/785	650/754	350/400
400/500	785/965	754/930	400/500
500/630	965/1210	930/1180	500/630
630/710	1210/1465	1180/1430	630/710

2.4 Technical Features

	Technical Features	Description
Input	Input voltage range	1AC 220V±15%, 3AC 220V±15%, 3AC 380V±15%, 3AC 660V±10%
	Input frequency range	47~63Hz
	Power factor	≥95%
Control performance	Control mode	V/F control, non-PG vector control(SVC), PG vector control (FVC)
	V/F control	Line, multiple point, square V/F curve, V/F separation
	Operation command mode	Keypad control, Terminal control, Serial communication control
	Frequency Reference Source	Digital, analog, pulse frequency, serial communication, multi-step speed, simple PLC and PID The combination of multi-modes and the different modes can be switched.
	Overload capacity	G type: 150% rated current 60s, 180% rated current 3s P type: 120% rated current 60s, 150% rated current 3s
	Start torque	G type: 0.5Hz/150%(SVC), 0Hz/180%(FVC) P type: 0.5Hz/100%
	Speed adjusting range	1:100(SVC) 1:1000(FVC)
	Speed control accuracy	±0.5%(SVC) ±0.02% (FVC)
	Carrier frequency	0.5 to 16.0kHz; automatically adjust carrier frequency according to the load characteristics
	Frequency resolution	Digital setting: 0.01Hz. Analog setting: maximum frequency x 0.025%
	Torque boost	Automatic torque boost; manual torque boost 0.1~30%
	Acceleration and deceleration mode	Line or S-curve, 4 types of acceleration/deceleration time with the range of 0.0~6500.0 s
	DC brake	Supports starting and stopping DC brake;
	Jogging Control	Jog frequency range: 0.0Hz~50.00Hz; Jog Acc/Dec time: 0~6500.0s
	Simple PLC & multi-step speed operation	Built-in PLC or control terminal, 16 steps speed can be set
	Built-in PID	Built-in PID control to easily realize the close loop control for the process parameters (such as pressure, temperature, flow, etc.)
	Automatic voltage regulation(AVR)	Automatically maintain a constant output voltage when the voltage of electricity grid changes
Common DC bus	Common DC bus function: multiple inverters can use a common DC bus	
Traverse control	Traverse control function: multiple triangular pulse frequency control	
Fixed length control	Setting length control	
Timing control	Setting time range: 0~6500min	
Terminals	Input terminals	<ul style="list-style-type: none"> ● 6 programmable digital inputs, it can be extended to 4 digital inputs, one of which supports high speed pulse input; ● 1 analog voltage input 0~10VDC; ● 2 voltage input 0~10VDC or current input 0~20mA
	Output terminals	<ul style="list-style-type: none"> ● 1 open collector output, it can be extended to 1 high speed pulse output; ● 2 relay outputs; ● 2 analog output: voltage output 0~10VDC or current output 0~20mA
Human machine interface	LED Display	Can display setting frequency, output frequency, output voltage, output current, etc.
Environment & Protection class	Protection class	IP20
	Humidity & temperature	90%RH or less (no-condensation), -10℃~40℃. Inverter will be derated if ambient temperature exceeds 40℃
	Vibration	Under 20Hz 9.8m/s(1G), Over 20Hz 5.88m/s(0.6G)
	Store environment	≤1000M, indoor (no corrosive gas and liquid)
	Store temperature	-20℃~60℃
Cooling Mode	Forced air-cooling	

2.5 All components schematic diagram of AC drive

The following picture is all components and names of below 15kW plastic shell AC drive

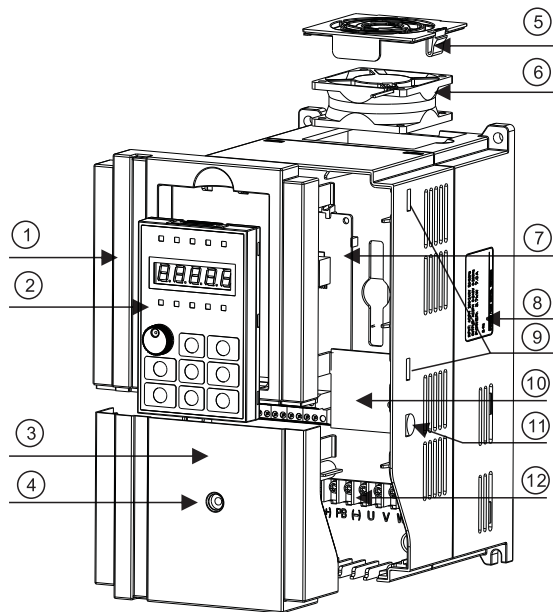

Figure 2-2 Schematic diagram of product structure

No.	Name	Description
①	Pre-cover	Used for install display keyboard and protect components
②	Keyboard	Used for amend and check inverter parameters, operation and other functions
③	Tail-hood	
④	Retaining screw of tail-hood	Used to fix tail-hood, and loosen this screw first while disassembly
⑤	Snap joint of fan	Used to fix fan, convenient to disassembly
⑥	Cooling fan	Internal heat dissipation of inverter
⑦	Control board	CPU board of inverter
⑧	Nameplate	
⑨	Snap joint of pre-cover	Used to fix pre-cover, total four on both left and right
⑩	Expansion board	Built-in multifunctional expansion board
⑪	Snap joint of tail-hood	Used to fix tail-hood, one on both left and right
⑫	Main loop terminal	

Chapter3 Installation

3.1 Installation

1. Installation environment:

- 1) Environment temperature: Surrounding environment temperature has a great impact on lifetime of AC drive, and the operation environment temperature of AC drive shall not exceed allowable temperature range (-10°C ~ 40°C).
- 2) While AC drive is installed on the surface of inflaming retardants, and enough space around is necessary for heat dissipation. When AC drive works, it will produce plenty of heats. And make vertical installation onto supporting holder with screw.
- 3) Please install it in some places that are not easy to vibrate. And the vibration shall not be larger than 0.6G. Especially pay attention to keep away from punching machine and other equipments.
- 4) Avoid to be installed where there are direct sunlights, moist surroundings and water drops.
- 5) Avoid to be installed where there are corrosivity, inflammability and explosive gas.
- 6) Avoid to be installed where there are oil contamination, dirt and metal dusts.

2. Reminder of installation site:

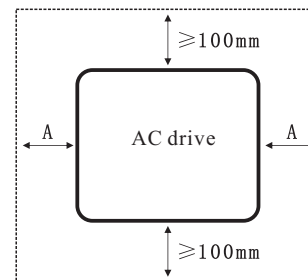

Explanation: When power of AC drive ≤22kW it means taking no account of size A is permissible. When the power >22kW, A shall be larger than 50mm.

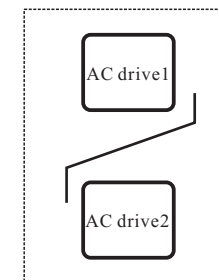

Explanation: When AC drive is installed upside and underside, please install thermal insulation guide plate as picture shows.

Figure 3-1 Installation diagram of AC drive

The focus of mechanical installation is the problem of heat dissipation. So please pay attention to following several points:

- 1) Please install AC drive vertically, convenient for heat diffusion upward. But it cannot be inverted. If there are many AC drives inside the cabinet, it will be better when they are installed side by side. When they need being installed upside and underside, please refer to the schematic diagram of picture 3-1 to install thermal insulation guide plate.
- 2) Refer to picture 3-1 for installation space. Guarantee heat dissipation space for AC drive. But in arrangement, please consider heat dissipation condition of other components inside the cabinet.
- 3) Installing support must be inflaming retarding materials.
- 4) For those application occasions with metal dusts, we advise to adopt radiator installation method outside the cabinet. The hermetic cabinet space shall be large enough.

3.2 Electrical installation

1.Specification list of specification devices of main circuit and electric specification :

Voltage (V)	AC drive power (kW)	Adaptive motor (kW)	Inverter input side (RST)		Recommend wiring size			
			Air switch model	Contactor model	Power line (input line /output line)	DC reactor	Braking circuit	Control signal line (external connection line)
220	0.55	0.55	DZ20-100(16A)	CJ20-16	1.5	4	1.5	0.5 ↓ 0.75
	0.75	0.75			2.5		2.5	
	1.5	1.5	DZ20-100(32A)	CJ20-40	4	6	4	
	2.2	2.2			4	6	4	
380	0.75	0.75	DZ20-100(16A)	CJ20-16	1.5	4	1.5	
	1.5	1.5			2.5		2.5	
	2.2	2.2			4		6	4
	3.7	3.7			4		6	4
	5.5	5.5	DZ20-100(32A)	CJ20-40	6	6	4	
	7.5	7.5			8			8
	11	11	DZ20-100(50A)	CJ20-40	10	16	6	
	15	15			16			16
	18.5	18.5	DZ20-100(63A)	CJ20-63	25	25	8	
	22	22			35			25*2(50)
	30	30	DZ20-100(80A)	CJ20-100	50	35*2(70)	10	
	37	37			70			50*2(95)
	45	45	DZ20-100(100A)	CJ20-160	70	70*2(150)	16	
	55	55			120			70*2(150)
	75	75	DZ20-200(200A)	CJ20-250	120	120*2(240)	25	
	93	93			150			120*2(240)
	110	110	DZ20-400(250A)	CJ20-400	150	150*2(300)	25*2(50)	
	132	132			185			150*2(300)
	160	160	DZ20-400(400A)	CJ40-500	185	185*2(370)	50*2(100)	
	187	187			250			185*2(370)
200	200	DZ20-630(500A)	CJ40-800	250	250*2(500)	50*2(100)		
220	220			315			250*2(500)	
250	250	DZ20-630(600A)	CJ40-1000	315	315*2(630)	50*2(100)		
280	280			400			315*2(630)	
315	315	DZ20-1250(700A)	CJ40-1000	400	400*2(800)	50*2(100)		
400	400			500			400*2(800)	
500	500	DZ20-1250(1250A)	CJ40-1000	500	500*2(1000)	50*2(100)		

2.Peripheral device wiring diagram :

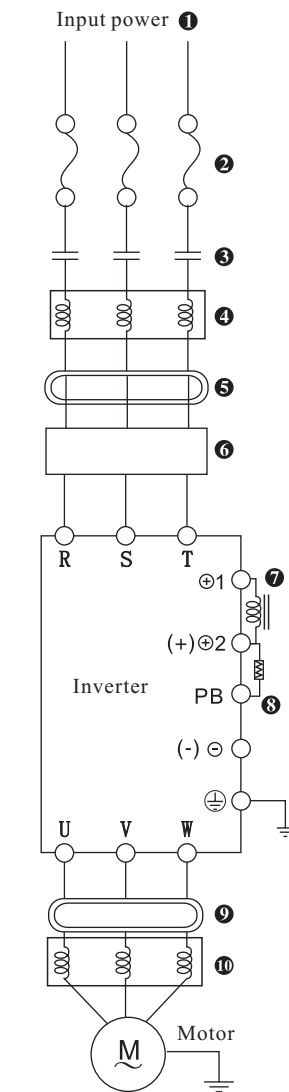
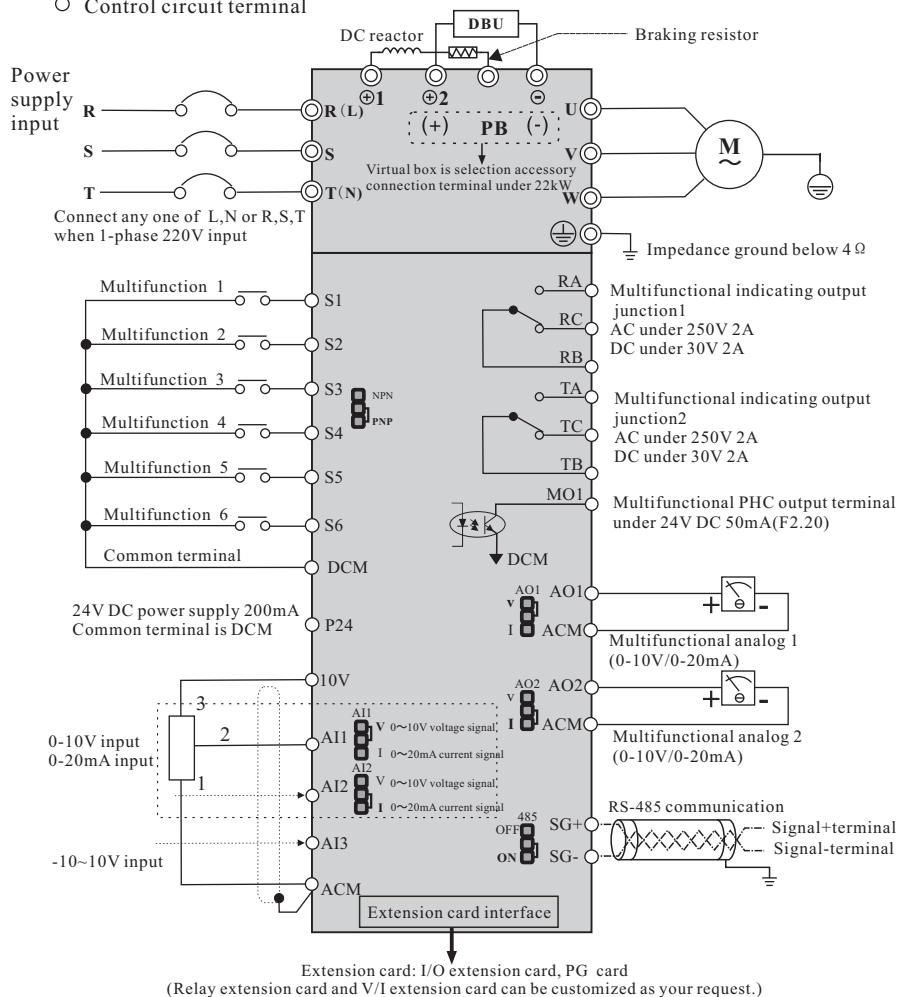

Figure3-2 Peripheral device wiring diagram

- Input power : voltage classes : 220V, 380V.**
- Fuse protector or residual-current circuit breaker:**
Please select fuse protector that accords with rated voltage and current classes. As power supply ON/OFF control of AC drive, it has the function of protecting drive. Please do not use it as Run/Stop switch over function of drive.
- Electromagnetic contactor:**
Please do not use electromagnetic contactor as the power switch of drive, because it will reduce lifetime of drive.
- AC electric reactor of input terminal :**
It can restrain harmonic wave of power line, or when voltage unbalance of main power supply exceeds 3% (and power capacity exceeds 500KVA) , and supply voltage changes acutely, it can improve power factor.
- Radio interference filter:**
Nearby equipments, such as wireless receiver, may generate electromagnetic interference noise. Magnetic resistance rejector helps to decrease radio noise.
- EMI rejector:**
Decrease the conductive noise on power line generated by AC drive.
- Direct current reactor**
AC drive $\geq 30kW$ reserves direct current reactor terminal ① ②
- Brake unit/ energy feedback, brake resistor**
When large inertia load needs rapid halt, brake unit and brake resistance shall be installed into AC drive. AC drive $\leq 22kW$ shall have built-in brake unit. Connect brake resistance to (+) and PB terminal. Brake unit shall be installed into AC drive $> 22kW$ additionally, and proceeds braking with appropriate braking resistance. You also can install FOLINN PUF100 energy feedback unit to replace brake unit and brake resistance, and give reborn energy feedback to power grid.
- Noise filter of output terminal:**
When AC drive has interference phenomenon over other electrical equipments, you can install ferrite bead into output cable to solve this problem. Generally three-turns reeling will have a best effect. If condition permission, it will be better to install noise filter.
- AC electric reactor of output end:**
Smooth electric wave form can help to decrease motor vibration caused by switch waveform of AC drive. When the connection line between AC drive and motor is more than 10m, it also can restrain harmonic wave.

Basic wiring diagram

- ⊙ Main circuit terminal
- Control circuit terminal



Notes: The general type AC drives $\leq 22\text{kW}$ have built-in brake unit, brake resistance (+) and PB terminal; (+) and (-) terminals are the plus or minus terminals of inverter's DC bus.

Reserved direct current reactor connection terminals $\geq 30\text{kW}$, ⊕1 ⊕2, ⊕2 and ⊖ terminals are used to connect energy feedback unit or brake unit.

When brake unit is used in high-power AC drives, you shall connect positive pole of brake unit to output terminal ⊕2 of direct current reactor. If it is connected to ⊕1 terminal, it will damage brake unit.

4. Jumper function declaration of main board:

- AI1: Analogue input 1 voltage/current signal conversion
- AI2: Analogue input 2 voltage/current signal conversion
- V: 0-10VDC voltage signal input
- I: 0-20mA analog current signal input

- AO1: Analog output 1 voltage/current signal conversion
- AO2: Analog output 1 voltage/current signal conversion
- V: 0-10VDC voltage signal output
- I: 4-20mA analogue current signal output

5. Main circuit terminals and connection

Danger

- ★ Confirm power switch stays in the state of OFF, and then start wiring operation, or it will give rise to electric shock hazard!
- ★ Wiring personnel must be those professional trainees, or it will cause equipment damages and personal injuries!
- ★ Reliable ground connection is necessary, or it will give rise to electric shock or fire alarm!

Danger

- ★ Confirm the input power is in accordance with the rated value of AC drive, or it will cause damages to AC drive!
- ★ Confirm motor is adaptive with AC drive, or it will cause damages to motor or cause AC drive protection!
- ★ Power supply shall not be connected to the terminals of U, V and W, or it will cause damages to AC drive!
- ★ Brake resistance shall not be connected directly to DC bus ⊕2, ⊖, or it will cause damages to AC drive!

1) Main circuit terminal description:

Main circuit wiring terminal $\leq 22\text{kW}$

Terminal identification	Name	Function description
R、S、T(L、N)	Main circuit power input terminal	Connect three-phase (one-phase) power supply
U、V、W	Output terminal of AC drive	Connect three phase motor
(+)、PB	Braking terminal	Connect external brake resistance
(+)、(-)	DC bus terminal	2 sets or more inverters use a common DC bus
⊖	Grounding terminal	Safety grounding

Main circuit wiring terminal $> 22\text{kW}$

Terminal identification	Name	Function description
R、S、T(L、N)	Main circuit power input terminal	Connect three-phase (one-phase) power supply
U、V、W	Output terminal of AC drive	Connect three phase motor
⊕2 ⊖	DC bus terminal	Use for connect brake unit, energy feedback, 2 sets or more AC drive use a common DC bus
⊕1 ⊕2	External reactor terminal	Connect external DC reactor
⊖	Grounding terminal	Inverter safety grounding

2) Attentions of wiring:

A. Input power L, N or R, S and T:

The connection of inverter input side has no phase sequence requirements.

B. DC bus ⊕2, ⊖terminals:

At the moment of power failure, DC bus ⊕2, ⊖terminals still have residual voltage, you just can touch it after internal “charge” power light is off confirming the voltage is less than 36V, it may cause electric shock.

When you select external brake unit for AC drive $\geq 30\text{kW}$, the polarity of ⊕2 and ⊖cannot be connected inversely, or it will cause damages to AC drive, or even fire hazard.

The wiring length of brake unit shall not be more than 10m, and only twisted pair or tight double-line is available in parallel.

Brake resistance cannot be connected onto DC bus directly, or it may cause damages to AC drive, or even fire hazard.

C. Brake resistance connection terminal (+) and PB:

AC drive $\leq 22\text{kW}$ and built-in brake unit.

The recommended value of brake resistance model selection reference and wiring distance shall be less than 5m, or it may cause damages to AC drive.

D. AC drive output side U, V and W:

AC drive output side shall not be connected to capacitor or surge absorber, or it will frequent protection of AC drive, or even damages.

When the cable of motor is overlong, the effects of distributed capacitance will generate electric resonance easily, and give rise to dielectric breakdown of motor. The generated large leakage current makes AC drive suffer over current protection. If cable length is more than 100m, alternating current output reactor shall be installed.

E. Grounding terminal ⊕:

Terminals must have been reliable ground connection, and resistance value of ground wire shall be less than 4Ω , or it will cause abnormal work of equipment, and even damages.

Grounding terminal ⊕ and null line N terminal of power supply cannot be shared.

6. Control circuit terminal and wiring

1) Schematic diagram of control circuit wiring terminal (Figure 3-4)

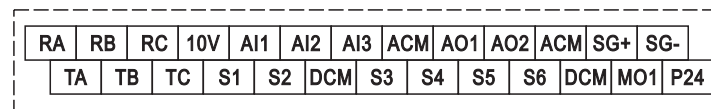

Figure 3-4: Schematic diagram of main control board wiring terminal

2) Control circuit terminal description:

Terminal identification	Terminal function description	
S1-DCM	Multifunctional input terminal 1	Function setting: F05.00~F05.05
S2-DCM	Multifunctional input terminal 2	
S3-DCM	Multifunctional input terminal 3	
S4-DCM	Multifunctional input terminal 4	
S5-DCM	Multifunctional input terminal 5	
S6-DCM	Multifunctional input terminal 6	
P24-DCM	Auxiliary power supply 24VDC 200mA	
10V-ACM	Input auxiliary power supply 10VDC 20mA	
AI1-ACM	Analog current input port 1: 0-10V or 0-20mA	Function setting: F05.18~F05.32
AI2-ACM	Analog current input port 2: 0-10V or 0-20mA	
AI3-ACM	Analog current input port 3: -10~10V	
AO1-ACM	Analog current output port 1: output 0-10V or 0-20mA	Function setting: F06.13~F06.20
AO2-ACM	Analog current output port 2: output 0-10V or 0-20mA	
SG+ SG-	Rs485 communication port	F13.00~F13.06
RA-RB-RC	Multifunctional connection point output, factory default is failure output	Function setting: F06.02~F06.04
TA-TB-TC	Multifunctional connection point output, factory default is output in operating	
MO1-DCM	Multifunctional collector output port of open circuit	

3) Control circuit terminal wiring explanation:

A. Analog input terminal:

As the weak analog voltage signal will suffer external disturbance easily, generally shield cable is required, and the wiring distance shall be kept as short as possible, and no more than 20m will be better, as follows:

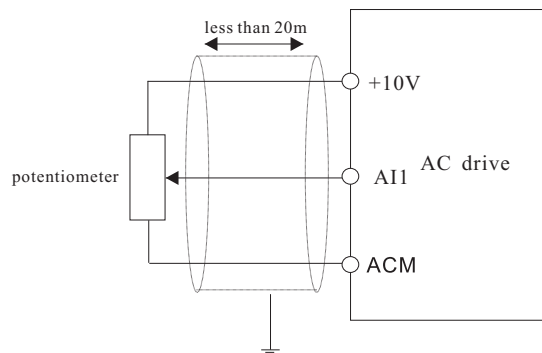

Figure 3-5 Schematic diagram of analog input terminal wiring

At some occasion where analog signal suffers severe interference, filter condenser or ferrite core shall be installed at the side of analog signal source, as Figure 3-6 shows:

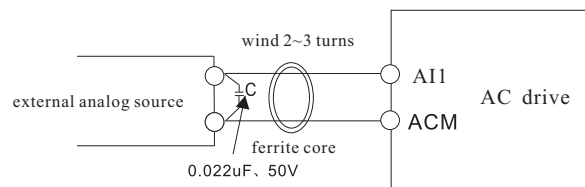

Figure 3-6 Analog input terminal with filter devices

B. Digital input terminal:

AC drive receives figure signal upon its judging of these terminals' states. So the external contactors shall be those connection points with high reliability over weak signals. If the applied open collector output to digital input terminal of AC drive provides 0N/0FF signal, you shall consider the false operation caused from the power crosstalk. We advise to adopt contactor control mode.

C. Digital output terminal:

When driving relay is required for digital output terminals, absorber diode shall be installed at both sides of relay coil, or it will cause damages to DC 24V power supply.

Attention: The polarity of absorber diode must be installed correctly, as following picture shows. Or when digital output terminals are outputted, it will cause DC 24V power supply damaged.

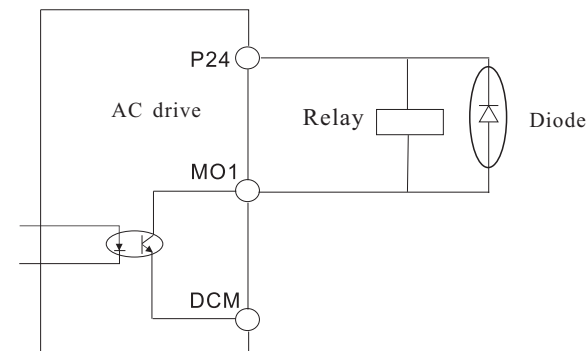

Figure 3-7 Wiring diagram of digital output terminal

7. Treatment of EMC problem:

I. Effects of harmonic wave

1. Higher harmonic wave of power supply will cause damages to inverter. So in some places with bad power grid quality, we advise to install AC input reactor.

2. As higher harmonic wave exists at the output side of AC drive, the application of capacitor to improve power factor and surge suppressor at output side may lead to electric shock, or even damages to equipment, so capacitor or surge suppression device cannot be installed at output side.

II. Electromagnetic interference and treatment

1. Electromagnetic interference has two categories: One is peripheral electromagnetic noise's interference on AC drive, which will give rise to false operations of inverter itself. But the effects of such interference usually are small, because AC drive has been processed internally in design about this interference, and it has a strong anti-interference capability. The other one is AC drive's effects on peripheral equipments.

Common handling methods:

A. AC drive and other electrical products should ground well, and the ground resistance shall not more than 4Ω.

B. It will be better if power line of AC drive won't be placed in parallel with circuit of control line. If condition permission, please arrange power lines vertically.

C. At those occasions with a high anti-interference requirement, shield cable shall be used between AC drive and power line of motor, and reliable ground connection also is necessary for shielding layer.

D. For the leading wire of interrupted equipment, we advise to adopt twisted pair shielding control line, and reliable ground connection also is necessary for shielding layer.

2. Handling methods of interference from peripheral electromagnetic equipment on AC drive. Electromagnetic effects on inverter generally result from the installation of many relays, contactors or electromagnetic contactors near AC drive. When AC drive has false operation from the interference, please try to solve it with following methods:

A. Install surge suppressor on the devices that make interference.
 B. Install filter at signal input terminal of AC drive.
 C. The leading wire of AC drive's control signal line and detection circuit shall be shield cable, and reliable ground connection also is necessary for shielding layer.
 3) The handling methods of interference on peripheral equipments from the noises of AC drive:
 This part of noise can be divided into two categories: One is the radiation of AC drive itself, and the other one is the radiation of the leading wire from inverter to motor. These two kinds of radiations make the leading wires surface of peripheral electrical equipments suffer electromagnetic and electrostatic induction, which will lead to false operations of equipments. About these several different disturbed conditions, please refer to following methods to resolve them:

A. Instrument, receiver, sensor and other equipment for measurement, generally have a weaker signal. If they are placed near AC drive or in a same control cabinet, they will suffer interference and operate falsely. So we advise to take following methods: Keep away from interference source; Signal line shall not be placed with power line in parallel, especially shall not be tied up together in parallel, and please adopt shield cable signal line and power line; Install linear filter or radio noise filter at the input and output sides of AC drive.

B. When interrupted equipments and AC drive share a same power supply, if above methods still cannot help to eliminate interference, you shall install linear filter or radio noise filter between AC drive and power supply.

C. Separated ground connection for peripheral equipments can help to eliminate the interference from ground wires' leakage current of AC drive while common-grounding.

III. Leakage current and treatment

Leakage current has two categories when inverter is in service: One is leakage current over the ground: and the other is leakage current between lines.

1. The factors of influencing leakage current over the ground and solutions:

Distributed capacitances exist between wire and ground. The larger distributed capacitances are, the larger the leakage current will be: Effectively decreasing the distance between AC drive and motor can reduce distributed capacitances. The larger carrier frequency is, the larger the leakage current will be. Reducing carrier frequency can decrease leakage current effectively. But reducing carrier frequency will result in the increase of motor noise, so please note this. Installing electric reactor also is an effective method to solve leakage current.

Leakage current will increase with enlargement of loop current, so when the power of motor is large, the relevant leakage current also will be large.

2. The factors of influencing electric current between lines and solutions:

Distributed capacitances exist between output wires of AC drive. If the electric current passing the circuit contains higher harmonic, it may give rise to resonance and leakage current. If you use thermal relay, it may cause false operation at this time.

The solution is to decrease carrier frequency or install output reactor. We advise not to install thermal relay before you use the motor of AC drive, but apply the electronic overcurrent protection function of AC drive.

Chapter 4 Operation and Display

4.1 Keypad description

● Keypad explanation and function

Keypad locates above AC drive, and can be divided into two parts: display area and control area. Display area shows parameter setting mode and different run state. Control area is communication interface for users and AC drive.

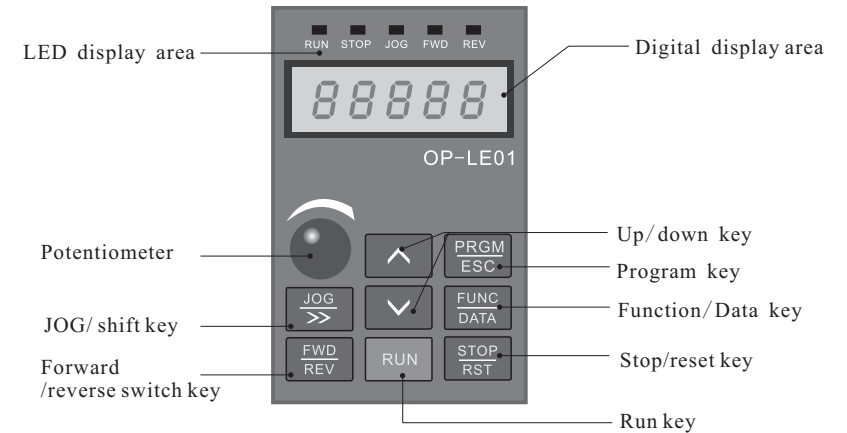

Figure 4-1 Schematic diagram of operation panel

PRGM ESC	PRGM/ESC Program key: Enter first level menu or exit parameter group
FUNC DATA	FUNCTION/DATA In the mode of normal operation, press this key to display all items of status and information of AC drive, such as frequency command, output frequency and output current; In the mode of program, press this key to display parameters, and press again to write modified data into the internal storage.
FWD REV	FORWARD/REVERSE Press the key of forward/reverse turning to slow down the motor to 0Hz, and acceleration in negative direction to the setting frequency command.
JOG >>	JOG/ >> Press this key to execute jog frequency command; In the mode of parameter operation, work as the left shift key.

	RUN Used to start AC drive operation.(This key has no effect when the drive is set to terminal run.)
	STOP/RST Used to stop the AC drive operation.If the AC drive has stopped due to a fault, press this key to reset the drive.
	UP/DOWN Used to select parameter item and modify parameter

● Digital display item and description

1.operating state (display item selection refer to parameter F07.03, F07.04)

display code	item description	operation
H	setting frequency	Press key
P	operation frequency	Press key
C	output current	Press key
d	output voltage	Press key
n	operation speed	Press key
t	output torque	Press key
f	output power	Press key
U	bus voltage	Press key
A	PID setting value	Press key
b	PID feedback value	Press key
l	input terminal state	Press key
o	output terminal state	Press key
u	analog AI1 value	Press key
c	analog AI2 value	Press key
r	analog AI3 value	Press key
n	timing value	Press key
L	length value	Press key

2. In halted state (Refer to more details of display items selection in F07.05) :

Display code	Display items explanation	Operating instructions
H	Setting frequency	Press key
U	bus voltage	Press key
l	Input terminal state	Press key
o	Output terminal state	Press key
A	PID setting value	Press key
u	analog AI1 value	Press key
c	analog AI2 value	Press key
r	analog AI3 value	Press key
n	timing value	Press key
L	length value	Press key

4. 2 Function code examining and modifying methods explanation:

The operation panel for AC drives adopts three-level menu structure for parameter setting and other operations. The three-level menus respectively are: functional parameter group (first-level menu) → function code (second-level menu) → function code setting value (third-level menu). Operational process is shown in Figure 4-2:

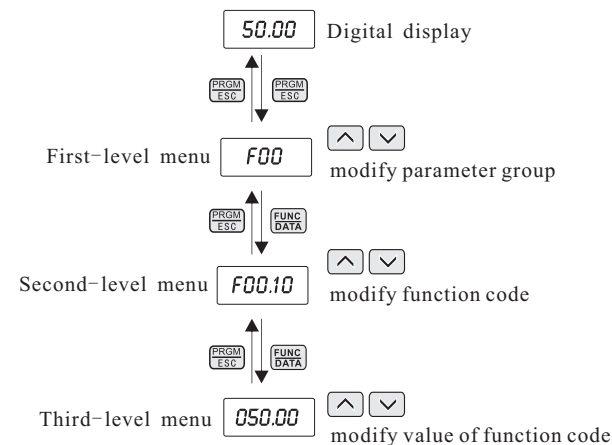
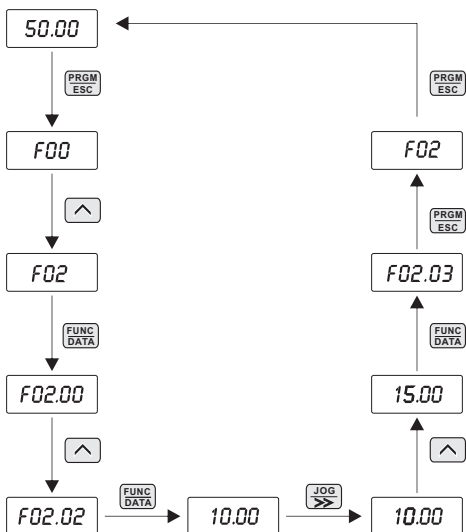

Figure 4-2 Operation flow chart of three-level menu

Explanation: In third-level menu operation, press PRGM or DATA to return to second-level menu. The difference between them: Press DATA to store the setting parameters into control panel, return to second-level menu, and automatically shift to next function code; Press PRGM to return to second-level menu directly without saving parameters, and then return to function code.

For example: Change the function code F1.02 from 10.00Hz to 15.00Hz.
(Bold means flash bit) :



Picture 4-3 Example for parameter changing

In third-menu state, if parameter can not flicker, it means this code can not be changed, and the reason may be:

1. This parameter of function code cannot be changed, such as actually detected parameter, and running record parameter.
2. In running status, this function code cannot be changed. And it can be changed only when inverter is stopped.

4.3 How to view status parameters:

In stop or running status, LED nixie tube can be used to display the multiple state parameters of AC drive. The function code F07.03 (operating parameter1) and F07.05 (stop parameter) can be used to select whether this state parameter shall be displayed.

Please refer to the function code F07.03~F07.05 for more explanations. DATA is available for circular switch over to display the state parameter of halting state or running state.

In stop status, total 13 stop status parameters are available for selection to be displayed or not, and respectively are: setting frequency, bus voltage, input terminal status, output terminal status, PID setting, analog AI1 value, analog AI2 value, analog AI3 value, timing value, length value, PLC state, load speed, input pulse frequency(kHz).

Positionally select whether display function F07.05, and switch to display the selected parameters upon the sequence of FUNC/DATA.

In running status, total 32 status parameters are available for selection to be displayed or not, and respectively are: setting frequency, running frequency, output current, output voltage, running speed, output torque, output torque, PID setting value, bus voltage, PID feedback value, input terminal status, output terminal status, analog AI1 value, analog AI2 value, analog AI3 value, timing value, length value. Positionally select whether display function F07.03/F07.04, and switch to display the selected parameters upon the sequence of FUNC/DATA.

If AC drive was power cut and then power on again, parameters is display the selected parameter before power cut.

4.4 Password setting:

The AC drives provide user password defensive function. When F07.00 is set to non-0, it is user password. While quit function code editing state, password protection will take effect. Press PRGM/ESC again to enter function code editing state, it will display "0.0.0.0.0.". User must enter password correctly, or he cannot get access.

If cancel password protection function, set F07.00 to 0.

4.5 Self-learning of motor parameters (when vector control function):

When you select vector control mode without PG, before inverter is running, you must input nameplate parameters of motors correctly. AC drives will match standard motor parameters upon the nameplate parameters. Vector control mode has a strong dependency on motor parameters. To obtain a good control performance, you shall get the exact parameters of controlled motors.

The operating steps of motor parameters self-learning as below:

First select operation instruction channel (F00.01) as keypad instruction channel. Then input following parameters according to motor's actual parameters:

- F02.01: Asynchronous motor 1 rated power;
- F02.02: Asynchronous motor 1 rated frequency;
- F02.03: Asynchronous motor 1 rated speed;
- F02.04: Asynchronous motor 1 rated voltage;
- F02.05: Asynchronous motor 1 rated current.

If motors can be separated with loads totally, please select 2 in F02.37 (dynamic self-learning), and then press "RUN" on control panel, AC drives will calculate parameter automatically:

- F02.06: Asynchronous motor 1 stator resistance;
- F02.07: Asynchronous motor 1 rotor resistance;
- F02.08: Asynchronous motor 1 stator and rotor leakage inductance;
- F02.09: Asynchronous motor 1 stator and rotor mutual inductance;
- F02.10: Asynchronous motor 1 no-load current;

If motors cannot be separated with loads totally, please select 1 in F02.37 (static self-learning), and then press "RUN" on control panel.

AC drives will measure these three parameters: stator resistance, rotor resistance and leakage inductive reactance in sequence, don't measure excluding mutual inductive reactance and no-load current of motors. Users can calculate these two parameters according to motor nameplate: rated voltage U, rated current I, rated frequency f and power factor η.

The computing methods of motor no-load current and motor mutual inductance are described as below, thereinto, L_s is motor leakage inductive reactance.

$$\text{No-load current: } I_0 = I \cdot \sqrt{1 - \eta^2}$$

$$\text{Mutual inductance calculation: } L_m = \frac{U}{2\sqrt{3}\pi f \cdot I_0} - L_s$$

I_0 is no-load current, L_m is mutual inductive reactance, and L_s is leakage inductive reactance.

Chapter 5 Function & Parameter Table

The functional parameters of AC drives are grouping by function, total 16 groups from F00~F15. Each functional group includes several function codes. Function codes adopt three-level menu, for example, “F05.08” means 8th function code of the functions in group F05.

For convenience of setting function codes, while operating with operation panel, function group number corresponding first-level menu, function code number corresponding second-level menu, and function code parameters corresponding third-level menu.

1. Contents note of function table is described as below:

First column “function code”: Functional parameter set and parametric number;

Second column “name”: Full name of functional parameters;

Third column “setting range”: Valid set value range of functional parameters;

Fourth column “factory default”: Original factory default of functional parameters;

Fifth column “modify”: Alteration property of functional parameters (whether or not it is permitted to modify and modification conditions) and the explanations are described as below:

“※”: it means the setting value of this parameter can be modified when AC drive is in stop or running state;

“●”: it means the setting value of this parameter cannot be modified when AC drive is in running state;

“**”: it means the numerical value of this parameter is practical detection record value, and cannot be modified;

“##”: it means the numerical value of this parameter is “factory parameter”, and is limited to be set by manufacturers. Users are prohibited about such operation.

Sixth column “No. ”: Serial number of this function code in the whole function codes, as well as the store address in communication.

(AC drives have already made automatic inspection constraint about the modification property of all parameters, which can help users to avoid faults in modification.)

2. “Factory default” refers to the numerical value after function code parameters are renovated when you take factory reset operation; but the actually detective parameter values or recorded values won’t be renovated.

3. To make more effective parameter protection, AC drives provide password protection for function codes. After users set password (the parameter of user password, F07.00 set to non-0), and press PRGM/ESC to enter into user parameter editing state, the system will enter into user password authorization state, and display “0.0.0.0.0.”. The manipulator must input user password correctly, or he cannot get access to it. In the unlocked state of password protection, user password can be altered at any time, and user password will be confirmed as the last input numerical value. When F07.00 is set to 0, user password can be canceled; while power on, F07.00 set to non-0, then parameters are protected by password.

4. While function code parameters are altered with serial communications, any functions of user password still keep to above regulations.

Function & Parameter Table

Function code	Name	Description(setting range)	Factory Default	Change
Group F00: Standard Function Parameters				
F00.00	Speed control mode	0: non-PG vector control (SVC) 1: PG vector control (FVC) 2: V/F control	2	●
F00.01	Command source selection	0: keypad control 1: terminal control 2: RS 485 communication control	0	※
F00.02	Run command source of communication	0: Modbus communication card	0	※
F00.03	Max.output frequency	50.00Hz~600.00Hz	50.00Hz	●
F00.04	Run frequency upper limit	F00.05~F00.03 (max.frequency)	50.00Hz	※
F00.05	Run frequency lower limit	0.00Hz~F00.04(run frequency upper limit)	00.00Hz	※
F00.06	Frequency A command selection	0: keypad, no retentive upon power failure 1: keypad, retentive upon power failure 2: analog AI1 3: analog AI2 4: analog AI3 5: pulse (HDI) 6: multi-speed running 7: simple PLC 8: PID control 9: RS485 Communication 10: potentiometer	0	●
F00.07	Frequency B command selection	same as F00.06	0	●
F00.08	Range of frequency B command selection	0: relative to maximum frequency 1: relative to frequency A command	0	※

Function code	Name	Description(setting range)	Factory Default	Change
F00.09	Frequency source combination mode	0: frequency A command 1: frequency B command 2: switch over between frequency A command and frequency B command 3: A+B 4: A-B 5: MAX (A and B) 6: MIN (A and B)	0	※
F00.10	Keypad setting frequency	0.00Hz~F00.03 (max. frequency)	50.00Hz	※
F00.11	Frequency reference resolution	1:0.1Hz 2:0.01Hz	2	●
F00.12	Acceleration time 1	0.00s~6500.0s	Model dependent	※
F00.13	Deceleration time 1	0.00s~6500.0s	Model dependent	※
F00.14	Acceleration/Deceleration time unit	0:1s 1: 0.1s 2: 0.01s	1	●
F00.15	Acceleration/Deceleration time base frequency	0:max.frequency (F00.03) 1:setting frequency 2:100Hz	0	●
F00.16	Rotation direction	0: same direction 1: reverse direction	0	※
F00.17	Carrier frequency	0.5kHz~8.0kHz	Model dependent	※
F00.18	Carrier frequency adjustment with temperature	0: No 1: Yes	1	※
F00.19	Source of frequency upper limit	0: set by F00.04 1: analog AI1 2:analog AI2 3:analog AI3 4:pulse(HDI) 5:RS485 communication	0	●
F00.20	Frequency upper limit offset	0.00Hz~max.frequency (F00.03)	00.00Hz	※
F00.21	Base frequency for UP/DOWN modification during running	0: running frequency 1: set frequency	0	●

Function code	Name	Description(setting range)	Factory Default	Change
F00.22	Binding command source to frequency source	Unit digit: (Binding keypad command to frequency source) 0: no binding 1: keypad setting 2: analog AI1 3: analog AI2 4: analog AI3 5:pulse setting (HDI) 6: multi-speed run setting 7: Simple PLC 8: PID control 9: RS485 communication Ten's digit (Binding terminal command to frequency source) Hundred' s digit (Binding communication command to frequency source) Thousands digit: (Binding auto-operation command to frequency source)	0000	※
F00.23	Range of frequency B source during superposition	0%~150%	100%	※
F00.25	Frequency offset of frequency B source during superposition	0.00Hz~max.frequency F00.03	00.00Hz	※
F00.26	Retentive of keypad setting frequency upon power failure	0: no retentive 1: retentive	0	※
F00.27	Motor model selection	0: G type (constant torque load) 1: P type (variable torque load)	Model dependent	**
F00.28	Function parameter restore	0:no operation 1: restore factory defaults,not include motor parameter 2: clear fault file	0	●
F00.29	Reserved	-		
F00.30	Reserved	-		

Function code	Name	Description(setting range)	Factory Default	Change
Group F01: Start-stop Control Parameters				
F01.00	Start mode	0:direct start 1:rotational speed tracking restart (valid on V/F control) 2: pre-excited start	0	※
F01.01	Startup frequency	0.00Hz~10.00Hz	0.00Hz	※
F01.02	Startup frequency holding time	0.0s~100.0s	0.0s	●
F01.03	Startup DC braking current/ Pre-excited current	0%~100%	50%	●
F01.04	Startup DC braking time/ Pre-excited time	0.0s~100.0s	0.0s	●
F01.05	Acceleration/ deceleration mode	0: line Acc/Dec time 1: S curve Acc/Dec A 2: S curve Acc/Dec B	0	●
F01.06	Time proportion of S-curve start segment	0.0%~ (100.0%-F01.07)	30.0%	●
F01.07	Time proportion of S-curve end segment	0.0%~ (100.0%-F01.06)	30.0%	●
F01.08	Stop mode	0: deceleration to stop 1:stop freely	0	※
F01.09	Initial frequency of stop DC braking	0.00Hz~F00.03 (max. frequency)	0.00Hz	※
F01.10	Waiting time of stop DC braking	0.0s~100.0s	0.0s	※
F01.11	Stop DC braking current	0%~100%	50%	※
F01.12	Stop DC braking time	0.0s~100.0s	0.0s	※
F01.13	Rotational speed tracking mode	0: start from frequency at stop 1: start from zero speed 2: start from max. frequency	0	●
F01.14	Rotational speed tracking speed	1~100	20	※
F01.15	Brake usage rate	0%~100%	100%	※

Function code	Name	Description(setting range)	Factory Default	Change
Group F02: Motor 1 Parameters				
F02.00	Motor type selection	0:common asynchronous motor 1:variable frequency asynchronous motor	0	●
F02.01	Rated power of asynchronous motor 1	0.1kW~1000.0kW	Model dependent	●
F02.02	Rated frequency of asynchronous motor 1	0.01Hz~F00.03 (max. frequency)	Model dependent	●
F02.03	Rated speed of asynchronous motor 1	1rpm~65535rpm	Model dependent	●
F02.04	Rated voltage of asynchronous motor 1	1V~2000V	Model dependent	●
F02.05	Rated current of asynchronous motor 1	0.01A~655.35A (AC drive power<=55kW) 0.1A~6553.5A (AC drive power>55kW)	Model dependent	●
F02.06	Stator resistance of asynchronous motor 1	0.001Ω~65.535Ω (inverter power<=55kW) 0.0001Ω~6.5535Ω (AC drive power>55kW)	Model dependent	●
F02.07	Rotor resistance of asynchronous motor 1	0.001Ω~65.535Ω (AC drive power<=55kW) 0.0001Ω~6.5535Ω (AC drive power>55kW)	Model dependent	●
F02.08	Leakage inductive reactance of asynchronous motor 1	0.01mH~655.35mH (AC drive power<=55kW) 0.001mH~65.535mH (AC drive power>55kW)	Model dependent	●
F02.09	Mutual inductive reactance of asynchronous motor 1	0.1mH~6553.5mH (inverter power<=55kW) 0.01mH~655.35mH (AC drive power>55kW)	Model dependent	●
F02.10	No-load current of asynchronous motor 1	0.01A~F02.05 (inverter power<=55kW) 0.1A~F02.05 (AC drive power>55kW)	Model dependent	●

Function code	Name	Description(setting range)	Factory Default	Change
F02.27	Encoder type	0:ABZ incremental encoder 1:UVW incremental encoder	0	●
F02.28	Selection of PG card	0:QEP1	0	●
F02.29	Encoder pulses per revolution	1~65535	2500	●
F02.30	AB phase sequence of ABZ incremental encoder	0: forward 1: reverse	0	●
F02.31	Encoder installation angle	0.0~359.9°	0.0°	●
F02.32	UVW phase sequence of UVW encoder	0: forward 1: reverse	0	●
F02.33	UVW encoder angle offset	0.0~359.9°	0.0°	●
F02.36	Encoder wire-break fault detection time	0.0s: No action 0.1~10.0s	0.0	●
F02.37	Self-learning of motor parameter	0: no self-learning 1: static self-learning of asynchronous motor 2: dynamic self-learning of asynchronous motor	0	●

Function code	Name	Description(setting range)	Factory Default	Change
Group F03: Vector Control Parameters				
F03.00	Proportional gain 1 of speed loop	1~100	30	※
F03.01	Integral time 1 of speed loop	0.01s~10.00s	0.50s	※
F03.02	Switch over low point frequency	0.00Hz~F03.05	5.00Hz	※
F03.03	Proportional gain 2 of speed loop	1~100	20	※
F03.04	Integral time 2 of speed loop	0.01s~10.00s	1.00s	※
F03.05	Switch over high point frequency	F03.02~F00.03 (max. frequency)	10.00Hz	※
F03.06	Vector control slip gain	50%~200%	100%	※
F03.07	Speed loop output filter	0.000s~0.100s	0.015s	※
F03.08	Vector control over excitation gain	0~200	64	※

F03.09	Torque upper limit source in speed control mode	0:F03.10 1:analog AI1 2:analog AI2 3:analog AI3 4:Pulse (HDI) 5:RS485 Communication 6:MIN(AI1,AI2) 7:MAX(AI1,AI2) (corresponding to F03.10 digital setting)	0	※
F03.10	Digital setting of torque upper limit in speed control mode	0.0%~200.0%	150.0%	※
F03.13	Excitation adjustment proportional gain	0~60000	2000	※
F03.14	Excitation adjustment integral gain	0~60000	1300	※
F03.15	Torque adjustment proportion gain	0~60000	2000	※
F03.16	Torque adjustment integral gain	0~60000	1300	※
F03.17	Speed loop integral property	Units' digit: integral separation 0: invalid 1: valid	0	※
F03.21	Field weakening automatic adjustment gain	10%~500%	100%	※
F03.22	Generation power limitation enable	0: invalid 1: full effective 2: constant speed effective 3: deceleration effective	0	※
F03.23	Speed/torque control mode selection	0: speed control 1: torque control	0	●
F03.24	Torque setting mode selection	0: digital setting (F03.26) 1:analog AI1 2:analog AI2 3:analog AI3 4:PULSE (HDI) 5:RS485 Communication 6:MIN(AI1,AI2) 7:MAX(AI1,AI2) (corresponding to F03.26 digital setting)	0	●

Function code	Name	Description(setting range)	Factory Default	Change
F03.26	Torque setting by keypad	-200.0%~200.0%	150.0%	※
F03.28	Upper frequency limit of forward when torque control	0.00Hz~F00.03(max. frequency)	50.00Hz	※
F03.29	Upper frequency limit of reverse when torque control	0.00Hz~F00.03 (max. frequency)	50.00Hz	※
F03.30	Torque control acceleration time	0.00s~650.00s	0.00s	※
F03.31	Torque control deceleration time	0.00s~650.00s	0.00s	※
Group F04: V/F Control Parameters				
F04.00	Motor1 V/F curve setting	0: linear V/F 1: multi-point V/F 2: square V/F 3: V/F complete seperation 4: V/F half seperation	0	●
F04.01	Motor 1 torque boost	0.0%: (auto torque boost) 0.1%~30.0%	Model dependent	※
F04.02	Cut-off frequency of motor 1 torque boost	0.00Hz~F00.03 (max. frequency)	50.00Hz	●
F04.03	Motor1 V/F frequency point 1	0.00Hz~F04.05	0.00Hz	●
F04.04	Motor1 V/F voltage point 1	0.0%~100.0%	0.0%	●
F04.05	Motor1 V/F frequency point 2	F04.03~F04.07	0.00Hz	●
F04.06	Motor1 V/F voltage point 2	0.0%~100.0%	0.0%	●
F04.07	Motor1 V/F frequency point 3	F04.05~F02.02 (motor rated frequency)	0.00Hz	●
F04.08	Motor1 V/F voltage point 3	0.0%~100.0%	0.0%	●
F04.09	Motor1 V/F slip compensation gain	0.0%~200.0%	0.0%	※
F04.10	V/F over-excitation gain	0~200	64	※
F04.11	V/F oscillation suppression gain	0~100	Model dependent	※

F04.13	Voltage source for V/F separation	0: digital setting (F04.14) 1: analog AI1 2: analog AI2 3: analog AI3 4: pulse (HDI) 5: multi-speed operation 6: simple PLC 7: PID control 8: RS485 Communication (corresponding F02.04 digital setting)	0	※
F04.14	Digital setting V/F separation of voltage	0V~F02.04(motor rated voltage)	0V	※
F04.15	Voltage digital setting for V/F separation	0.0s~1000.0s note: time from 0V to motor rated voltage (F02.04)	0.0s	※
F04.16	Voltage drop time for V/F separation	0.0s ~ 1000.0s Note: it refers to the time when 0V changes to rated voltage of motor	0.0s	※
F04.17	Shut down mode for V/F separation	0: frequency / voltage reduced to 0 independently 1: voltage reduced to 0, the frequency reduced again	0	※
F04.18	Overcurrent stall action current	50 ~ 200%	150%	●
F04.19	Over current stall suppression enable	0: disabled 1: enabled	1	●
F04.20	Over current stall suppression gain	0 ~ 100	20	※
F04.21	Current compensation coefficient of double speed over-current stall action	50 ~ 200%	50%	●
F04.22	Overvoltage stall action voltage	200.0V ~ 2000.0V	Model dependent	●
F04.23	Over current stall enable	0: disabled 1: enabled	1	●
F04.24	Over voltage stall suppression frequency gain	0 ~ 100	30	※
F04.25	Overvoltage stall suppression voltage gain	0 ~ 100	30	※
F04.26	Overpressure stall maximum rise frequency limitation	0 ~ 50Hz	5Hz	●
F04.27	Slip compensation time coefficient	0.1 ~ 10.0s	0.5	※

Function code	Name	Description(setting range)	Factory Default	Change
Group F05: Input Terminals				
F05.00	S1 terminal function selection		1	●
F05.01	S2 terminal function selection	0: no function	2	●
F05.02	S3 terminal function selection	1: forward run	9	●
F05.03	S4 terminal function selection	2: reverse run	12	●
F05.04	S5 terminal function selection	3: 3-wire operation control	13	●
F05.05	S6 terminal function selection	4: forward jog	4	●
F05.06	S7 terminal function selection	5: reverse jog	0	●
F05.07	S8 terminal function selection	6: coast to stop	0	●
F05.08	S9 terminal function selection	7: fault reset	0	●
F05.09	HDI terminal function selection	8: external fault normal open input	0	●
		9: UP command		
		10: DOWN command		
		11: clear UP/DOWN (terminal, keypad)		
		12: multi-speed terminal 1		
		13: multi-speed terminal 2		
		14: multi-speed terminal 3		
		15: multi-speed terminal 4		
		16: Pause operation		
		17: Acc/Dec time selection 1		
		18: Acc/Dec time selection 2		
		19: frequency source switch over		
		20: run command switch over terminal		
		21: Acceleration/Deceleration prohibited		
		22: PID pause		
		23: PLC status reset		
		24: swing pause		

Function code	Name	Description(setting range)	Factory Default	Change
		25: terminal count		
		26: counter reset		
		27: length count input		
		28: length reset		
		29: torque control prohibited		
		30: pulse input (enabled only for HDI)		
		31: reserved		
		32: immediate DC braking		
		33: Normally closed (NC) input of external fault		
		34: frequency modification forbidden		
		35: reverse PID action direction		
		36: external STOP terminal 1		
		37: command source switch over terminal 2		
		38: PID integral pause		
		39: reserved		
		40: reserved		
		41: motor selection terminal 1		
		42: reserved		
		43: PID parameter switch over		
		44: reserved		
		45: reserved		
		46: speed / torque control switch over		
		47: emergency stop		
		48: external stop terminal 2		
		49: deceleration DC braking		
		50: clear the current running time		

Function code	Name	Description(setting range)	Factory Default	Change
F05.10	Input terminal valid mode selection 1	0: valid on high level 1: valid on low level units' digit: S1 tens' digit: S2 hundreds' digit: S3 thousands' digit: S4 ten thousands' digit: S5	00000	●
F05.11	Input terminal polarity selection 2	0: valid on high level 1: valid on low level units' digit: S6 tens' digit: S7 hundreds' digit: S8 thousands' digit: S9 ten thousands' digit: HDI	00000	●
F05.12	Filtering time of switch	0.000s~1.000s	0.010s	※
F05.13	Terminal control operation mode	0: 2-wire control 1 1: 2-wire control 2 2: 3-wire control 1 3: 3-wire control 2	0	●
F05.14	Terminal UP/DOWN rate	0.001Hz/s~65.535Hz/s	1.00Hz/s	※
F05.15	S1 delay time	0.0s~3600.0s	0.0s	●
F05.16	S2 delay time	0.0s~3600.0s	0.0s	●
F05.17	S3 delay time	0.0s~3600.0s	0.0s	●
F05.18	AI1 lower limit	0.00V~F05.20	0.00V	※
F05.19	Corresponding setting of AI1 lower limit	-100.0%~+100.0%	0.0%	※
F05.20	AI1 upper limit	F05.18~+10.00V	10.00V	※
F05.21	Corresponding setting of AI1 upper limit	-100.0%~+100.0%	100.0%	※
F05.22	AI1 input filter time	0.00s~10.00s	0.10s	※
F05.23	AI2 low limit	0.00V~F05.25	0.00V	※

Function code	Name	Description(setting range)	Factory Default	Change
F05.24	Corresponding setting of AI2 lower limit	-100.0%~+100.0%	0.0%	※
F05.25	AI2 upper limit	F05.23~+10.00V	10.00V	※
F05.26	Corresponding setting of AI2 upper limit	-100.0%~+100.0%	100.0%	※
F05.27	AI2 input filter time	0.00s~10.00s	0.10s	※
F05.28	AI3 lower limit	-10.00V~F05.30	0.00V	※
F05.29	Corresponding setting of AI3 lower limit	-100.0%~+100.0%	0	※
F05.30	AI3 upper limit	F05.28~+10.00V	4.00V	※
F05.31	Corresponding setting of AI3 upper limit	-100.0%~+100.0%	100.0%	※
F05.32	AI3 input filter time	0.00s~10.00s	0.10s	※
F05.33	HDI lower limit	0.00kHz~F05.35	0.00kHz	※
F05.34	Corresponding setting of HDI lower limit	-100.0%~+100.0%	0.0%	※
F05.35	HDI upper limit	F05.33~+100.00kHz	50.00kHz	※
F05.36	Corresponding setting of HDI upper limit	-100.0%~+100.0%	100.0%	※
F05.37	HDI frequency input filter time	0.00s~10.00s	0.10s	※
F05.38	AI curve selection	units' digit: AI curve selection 1: curve 1 (2 point, see F05.18~F05.21) 2: curve 2 (2 point, see F05.23~F05.26) 3: curve 3 (2 point, see F05.28~F05.31) 4: curve 4 (4 point, see F05.40~F05.47) 5: curve 5 (4 point, see F05.48~F05.55) tens' digit: AI2 curve selection hundreds' digit: AI3 curve selection	H.321	※
F05.39	Setting for AI less than minimum input	units' digit: (setting for AI1 less than minimum input) 0: corresponding to the minimum input set 1: 0.0% tens' digit: (setting for AI2 less than minimum input) setting selection hundreds' digit: (setting for AI3 less than minimum input)	H.000	※

Function code	Name	Description(setting range)	Factory Default	Change
F05.40	AI curve 4 lower limit	-10.00V~F05.42	0.00V	※
F05.41	AI curve 4 lower limit setting	-100.0%~+100.0%	0.0%	※
F05.42	AI curve 4 inflection point 1 input	F05.40~F05.44	3.00V	※
F05.43	AI curve 4 inflection point 1 input setting	-100.0%~+100.0%	30.0%	※
F05.44	AI curve 4 inflection point 2 input	F05.42~F05.46	6.00V	※
F05.45	AI curve 4 inflection point 2 input setting	-100.0%~+100.0%	60.0%	※
F05.46	AI curve 4 upper limit	F05.44~ +10.00V	10.00V	※
F05.47	AI curve 4 upper limit setting	-100.0%~+100.0%	100.0%	※
F05.48	AI curve 5 lower limit	-10.00V~F05.50	-10.00V	※
F05.49	AI curve 5 lower limit setting	-100.0%~+100.0%	-100.0%	※
F05.50	AI curve 5 inflection point 1 input	F05.48~F05.52	-3.00V	※
F05.51	AI curve 5 inflection point 1 setting	-100.0%~+100.0%	-30.0%	※
F05.52	AI curve 5 inflection point 2 input	F05.50~F05.54	3.00V	※
F05.53	AI curve 5 inflection point 2 setting	-100.0%~+100.0%	30.0%	※
F05.54	AI curve 5 upper limit	F05.52~ +10.00V	10.00V	※
F05.55	AI curve 5 upper limit setting	-100.0%~+100.0%	100.0%	※
F05.64	A11 jump point setting	-100.0%~100.0%	0.0%	※
F05.65	A11 jump point range setting	0.0%~100.0%	0.5%	※
F05.66	A12 jump point setting	-100.0%~100.0%	0.0%	※
F05.67	A12 jump point range setting	0.0%~100.0%	0.5%	※
F05.68	A13 jump point setting	-100.0%~100.0%	0.0%	※
F05.69	A13 jump point range setting	0.0%~100.0%	0.5%	※

Function code	Name	Description(setting range)	Factory Default	Change
Group F06: Output Terminals				
F06.00	HDO terminal output mode	0: Pulse output (HDOP) 1: Switch signal output (HDOR)	0	※
F06.01	HDOR output selection	0: no output	0	※
F06.02	Relay TA output selection (TA*TB*TC)	1: frequency reached 2: frequency-level detection	2	※
F06.03	Relay RA output selection (RA*RB*RC)	FDT1 output 3: fault output (stop)	0	※
F06.04	MO1 output selection	4: motor overload pre-warning 5: AC drive overload pre-warning 6: zero-speed running (no output at stop) 7: zero-speed running 2 (no output at stop) 8: frequency upper limit reached 9: frequency lower limit reached (no output at stop) 10: set count value reached 11: designated count value reached 12: length reached 13: PLC cycle complete 14: accumulative running time reached 15: frequency limited 16: torque limited 17: ready for RUN 18: AC drive running 19: A11>A12 20: undervoltage state output 22: reserved 23: reserved 24: accumulative power-on time reached 25: Frequency level detection FDT2 output	1	※

Function code	Name	Description(setting range)	Factory Default	Change
		26: frequency 1 reached 27: frequency 2 reached 28: current 1 reached 29: current 2 reached 30: timing reached 31: AI1 input limit exceeded 32: load becoming 0 33: reverse running 34: zero current state 35: module temperature reached 36: output current limit exceeded 37: Frequency lower limit reached (having output at stop) 38: Alarm output (keep running) 39: motor overheat warning 40: current running time reached		
F06.06	Output terminal valid mode selection	0: Positive logic 1: Negative logic Unit's digit: HDO Ten's digit: TA Hundred's digit: RA Thousand's digit: MO1	0000	※
F06.07	HDO delay time	0.0s~3600.0s	0.0s	※
F06.08	TA delay time	0.0s~3600.0s	0.0s	※
F06.09	RA delay time	0.0s~3600.0s	0.0s	※
F06.10	MO1 output delay time	0.0s~3600.0s	0.0s	※

Function code	Name	Description(setting range)	Factory Default	Change
F06.12	HDOP output selection		0	※
F06.13	AO1 output selection	0: setting frequency	0	※
F06.14	AO2 output selection	1: running frequency 2: output current 3: output voltage 4: output speed 5: output torque 6: output power 7: Pulse input (100% corresponding to 100.0kHz) 8: AI1 9: AI2 10: AI3 11: lenth 12: count value 13: RS485 communication 14: output current (100.0% corresponding to 1000.0A) 15: output voltage (100.0% corresponding to 1000.0V) 16: reserved	1	※
F06.15	AO1 offset coefficient	-100.0%~100.0%	0.0%	※
F06.16	AO1 gain	-10.00~+10.00	1.00	※
F06.17	AO2 offset coefficient	-100.0%~100.0%	0.0%	※
F06.18	AO2 gain	-10.00~+10.00	1.00	※
F06.19	AO1 output filter time	0~10.00	0	※
F06.20	AO2 output filter time	0~10.00	0	※
F06.21	HDO output filter time	0~10.00	0	※
F06.22	HDO output max.frequency	0.01kHz~100.00kHz	50.00kHz	※

Function code	Name	Description(setting range)	Factory Default	Change
Group F07: Keypad And Display				
F07.00	User password	0~65535	0	※
F07.02	STOP key function selection	0: STOP/RST key enabled only in keypad control 1: STOP/RST key enabled in any operation mode	1	※
F07.03	LED display running parameters 1	0000~FFFF Bit00: running frequency 1 (Hz) Bit01: set frequency (Hz) Bit02: output current (A) Bit03: output voltage (V) Bit04: load speed display Bit05: output power (kW) Bit06: output torque (%) Bit07: bus voltage (V) Bit08: PID setting Bit09: PID feedback value Bit10: input terminal status Bit11: output terminal status Bit12: AI1 voltage (V) Bit13: AI2 voltage (V) Bit14: AI3 voltage (V) Bit15: count value	H.008F	※

Function code	Name	Description(setting range)	Factory Default	Change
F07.04	LED display running parameters 2	0000 - FFFF Bit00: length value Bit01: PLC stage Bit02: pulse setting frequency(kHz) Bit03: running frequency 2 (Hz) Bit04: remaining running time Bit05: AI1 voltage before correction (V) Bit06: AI2 voltage before correction (V) Bit07: AI3 voltage before correction (V) Bit08: linear speed Bit09: current power-on time(Hour) Bit10: current running time (Min) Bit11: pulse setting frequency(Hz) Bit12: Rs485 communication setting value Bit13: encoder feedback speed(Hz) Bit14: main frequency A display(Hz) Bit15: auxiliary frequency B display (Hz)	H.0000	※
F07.05	LED display stop parameters	0000~FFFF Bit00: set frequency (Hz) Bit01: bus voltage (V) Bit02: input terminal status Bit03: output terminal status Bit04: PID setting Bit05: AI1 voltage (V) Bit06: AI2 voltage (V) Bit07: AI3 voltage (V) Bit08: Count value Bit09: Length value Bit10: PLC stage Bit11: Load speed Bit12: Pulse setting frequency (kHz)	H.0063	※

Function code	Name	Description(setting range)	Factory Default	Change
F07.06	Load speed display coefficient	0.0001~6.5000	1.0000	※
F07.07	Heatsink temperature of rectifier bridge	0.0℃~100.0℃	-	**
F07.08	Heatsink temperature of inverter module	0.0℃~100.0℃	-	**
F07.09	Software version	-	-	**
F07.10	Accumulative running time	0h~65535h	-	**
F07.11	Product number	-	-	**
F07.12	Number of decimal places for load speed display	0: 0 decimal place 1: 1 decimal place 2: 2 decimal places 3: 3 decimal places	1	※
F07.13	Accumulative power-on time	0h~65535h	-	**
F07.14	Accumulative power consumption	0~65535 kWh	-	**
Group F08: Auxiliary Functions				
F08.00	Acceleration time 2	0.0s~6500.0s	Model dependent	※
F08.01	Deceleration time 2	0.0s~6500.0s	Model dependent	※
F08.02	Acceleration time 3	0.0s~6500.0s	Model dependent	※
F08.03	Deceleration time 3	0.0s~6500.0s	Model dependent	※
F08.04	Acceleration time 4	0.0s~6500.0s	Model dependent	※
F08.05	Deceleration time 4	0.0s~6500.0s	Model dependent	※
F08.06	JOG running frequency	0.00Hz~F00.03 (max. frequency)	2.00Hz	※
F08.07	JOG acceleration time	0.0s~6500.0s	20.0s	※
F08.08	JOG deceleration time	0.0s~6500.0s	20.0s	※
F08.09	Jump frequency 1	0.00Hz~F00.03 (max. frequency)	0.00Hz	※
F08.10	Jump frequency 2	0.00Hz~F00.03 (max. frequency)	0.00Hz	※
F08.11	Frequency jump amplitude	0.00Hz~F00.03 (max. frequency)	0.00Hz	※
F08.12	Forward/Reverse rotation dead-zone time	0.0s~3000.0s	0.0s	※
F08.13	Reverse control	0: enabled 1: disabled	0	※
F08.14	Running mode when set frequency lower than frequency lower limit	0: run at frequency lower limit 1: stop 2: run at zero speed	0	※

Function code	Name	Description(setting range)	Factory Default	Change
F08.15	Accumulative power-on time threshold	0h~65000h	0h	※
F08.16	Accumulative running time threshold	0h~65000h	0h	※
F08.17	Startup protection	0: No 1: Yes	0	※
F08.18	Droop control	0.00Hz~10.00Hz	0.00Hz	※
F08.19	Motor switch over	0: Motor 1 1: Motor 2	0	●
F08.20	Frequency detection value (FDT1)	0.00Hz~F00.03 (max. frequency)	50.00Hz	※
F08.21	Frequency detection hysteresis (FDT hysteresis 1)	0.0%~100.0% (FDT1 level)	5.0%	※
F08.22	Frequency detection value (FDT2)	0.00Hz~F00.03 (max. frequency)	50.00Hz	※
F08.23	Frequency detection hysteresis (FDT hysteresis 2)	0.0%~100.0% (FDT2 level)	5.0%	※
F08.24	Detection range of frequency reached	0.0%~100.0% (F00.03 (max. frequency))	0.0%	※
F08.25	Jump frequency during acceleration/deceleration	0: disabled 1: enabled	0	※
F08.28	Frequency switch over point between acceleration time 1 and acceleration time 2	0.00Hz~F00.03 (max. frequency)	0.00Hz	※
F08.29	Frequency switch over point between deceleration time 1 and deceleration time 2	0.00Hz~F00.03 (max. frequency)	0.00Hz	※
F08.30	Terminal JOG preferred	0: disabled 1: enabled	1	※
F08.31	Any frequency reaching detection value 1	0.00Hz~F00.03 (max. frequency)	50.00Hz	※
F08.32	Any frequency reaching detection amplitude 1	0.0%~100.0% (F00.03 (max. frequency))	0.0%	※
F08.33	Any frequency reaching detection value 2	0.00Hz~F00.03 (max. frequency)	50.00Hz	※
F08.34	Any frequency reaching detection amplitude 2	0.0%~100.0% (F00.03 (max. frequency))	0.0%	※
F08.35	Zero current detection level	0.0%~300.0% (rated motor current)	5.0%	※
F08.36	Zero current detection delay time	0.01s~600.00s	0.10s	※
F08.37	Output overcurrent threshold	0.0% (no detection) 0.1%~300.0% (rated motor current)	200.0%	※
F08.38	Output overcurrent detection delay time	0.00s~600.00s	0.00s	※
F08.39	Any current reaching 1	0.0%~300.0% ((rated motor current)	100.0%	※

Function code	Name	Description(setting range)	Factory Default	Change
F08.40	Any current reaching 1 amplitude	0.0%~300.0% (rated motor current)	0.0%	※
F08.41	Any current reaching 2	0.0%~300.0% (rated motor current)	100.0%	※
F08.42	Any current reaching 2 amplitude	0.0%~300.0% (rated motor current)	0.0%	※
F08.43	Timing function	0: Disabled 1: Enabled	0	※
F08.44	Timing duration source	0: F08.45 1: analog AI1 2: analog AI2 3: analog AI3 (100% of analog input corresponds to the value of F8.45)	0	※
F08.45	Timing duration	0.0Min~6500.0Min	0.0Min	※
F08.46	AI1 input voltage lower limit	0.00V~F08.47	3.10V	※
F08.47	AI1 input voltage upper limit	F08.46~10.00V	6.80V	※
F08.48	Module temperature threshold	0°C ~ 100°C	75°C	※
F08.49	Cooling fan control	0: Fan working during running 1: Fan working continuously	0	※
F08.50	Wakeup frequency	Dormant frequency (F8.52) to maximum frequency (F00.03)	0.00Hz	※
F08.51	Wakeup delay time	0.0s~6500.0s	0.0s	※
F08.52	Dormant frequency	0.00 Hz to wakeup frequency (F08.50)	0.00Hz	※
F08.53	Dormant delay time	0.0s~6500.0s	0.0s	※
F08.54	Current running time reached	0.0Min~6500.0Min	0.0Min	※
F08.55	DPWM switch over running frequency upper limit	0.00Hz~Max.frequency (F00.03)	8.00Hz	※
F08.56	PWM modulation system	0: asynchronous modulation 1: synchronous modulation	0	※
F08.57	Dead zone compensation mode selection	0: no compensation 1: compensation mode 1 2: compensation mode 2	1	※
F08.58	Depth of PWM random	0: PWM random disabled 1~10: PWM carrier frequency random depth	0	※
F08.59	Rapid current limit	0: Disabled 1: Enabled	1	※

Function code	Name	Description(setting range)	Factory Default	Change
F08.60	Current detection compensation	100~110	105	※
F08.61	Under-voltage point	200V~1000V	Model dependent	※
F08.62	SVC optimize mode selection	0: no optimize 1: optimize mode 1 2: optimize mode 2	1	※
F08.63	Dead-zone time adjustment	100%~200%	150%	※
F08.64	Over-voltage point	200.0V~2500.0V	Model dependent	※
Group F09: Fault and Protection				
F09.00	Input phase loss protection	0: disabled 1: enabled	1	※
F09.01	Output phase loss protection	0: disabled 1: enabled	1	※
F09.02	Action selection at instantaneous power failure	0: Invalid 1: Decelerate 2: Decelerate to stop	0	※
F09.03	Voltage rally judging time at instantaneous power failure	0.00s~100.00s	0.50s	※
F09.04	Action judging voltage at instantaneous power failure	60.0%~100.0%(standard bus voltage)	80.0%	※
F09.05	Overvoltage stall gain	0~100	30	※
F09.06	Overvoltage stall protective voltage	120%~150%	130%	※
F09.07	Overcurrent stall gain	0~100	20	※
F09.08	Overcurrent stall protective current	100%~200%	150%	※
F09.09	Motor overload warning selection	0: disabled 1: enabled	1	※
F09.10	Motor overload pre-alarm warning detection levels	0.20~10.00	1.00	※
F09.11	Motor overload pre-alarm warning detection time	50%~100%	80%	※
F09.12	Protection upon load becoming 0	0: disabled 1: enabled	0	※
F09.13	Detection level of load becoming 0	0.0~100.0% (rated motor current)	10.0%	※
F09.14	Detection time of load becoming 0	0.0~60.0s	1.0s	※
F09.15	Over-speed detection value	0.0%~50.0% (F00.03 (max. frequency))	20.0%	※

Function code	Name	Description(setting range)	Factory Default	Change
F09.16	Over-speed detection time	0.0~60.0s	1.0s	※
F09.17	Detection value of too large speed deviation	0.0%~50.0% (F00.03 (max. frequency))	20.0%	※
F09.18	Detection time of too large speed deviation	0.0s~60.0s	5.0s	※
F09.19	Fault auto reset times	0~20	0	※
F09.20	Time interval of fault auto reset	0.1s~100.0s	1.0s	※
F09.21	Fault protection action selection 1	Unit's digit: motor overload(E007) 0: coast to stop 1: stop according to the stop mode 2: continue to run Ten's digit : power input phase loss (E012) Hundred's digit: power output phase loss (E013) Thousand's digit: external equipment fault(E00d) Ten thousand's digit: communication fault(E018)	00000	※
F09.22	Fault protection action selection 2	Unit's digit: encoder/PG card fault(E026) 0: coast to stop Ten's digit: EEPROM read-write fault(E021) 0: coast to stop 1: stop according to the stop mode Hundred's digit: reserved Thousand's digit: motor overheat(E036) Ten thousand's digit (Accumulative running time reached)(E020)	00000	※
F09.23	Fault protection action selection 3	Unit's digit: reserved Ten's digit: reserved Hundred's digit (Accumulative power-on time reached (E029) 0: coast to stop 1: stop according to the stop mode 2: continue to run Thousand's digit: off load (E030) 0: coast to stop 1: decelerate to stop 2: continue to run at 7% of rated motor frequency and resume to the set frequency if the load recovers	00000	※

Function code	Name	Description(setting range)	Factory Default	Change
		Ten thousand's digit :PID feedback lost during running (E02E) 0: coast to stop 1: stop according to the stop mode 2: continue to run		
F09.24	Fault protection action selection 4	Unit's digit : too large speed deviation (E034) 0: coast to stop 1: stop according to the stop mode 2: continue to run Ten's digit : motor over-speed(E035) Hundred's digit : initial position fault(E037)	000	※
F09.26	Frequency selection for continuing to run upon fault	0: Current running frequency 1: Set frequency 2: Frequency upper limit 3: Frequency lower limit 4: Backup frequency upon abnormality	0	※
F09.27	Current fault type		-	●
F09.28	2nd fault type	0: No fault 1: Overcurrent during acceleration (E004)	-	●
F09.29	1st fault type	2: Overcurrent during deceleration (E005) 3: Overcurrent at constant speed 4: Overvoltage during acceleration (E002) 5: Overvoltage during deceleration (E00A) 6: Overvoltage at constant speed (E003) 7: Undervoltage (E001) 8: Motor overload (E007) 9: AC drive overload (E008) 10: Power input phase loss (E012) 11: Power output phase loss (E013) 12: Module overheat (E00E) 13: Buffer resistance overload (E014)	-	●

Function code	Name	Description(setting range)	Factory Default	Change
		14: Contactor fault (E017) 15: External equipment fault (E00d) 16: Communication fault(E018) 17: Current detection fault (E015) 18: Motor auto-tuning fault (E016) 19: Running time reached (E020) 20: EEPROM read-write fault (E00F) 21: Short circuit to ground (E023) 22: PID feedback lost during running (E02E) 23: Encoder/PG card fault(E026) 24: AC drive hardware fault (E033) 25: Power-on time reached (E029) 26: Load becoming 0 (E030) 27: With-wave current limit fault (E032) 28: Too large speed deviation (E034) 29: Motor switch over fault during running (E038) 30: Motor over-speed (E035) 31: Motor overheat (E036) 32: Initial position fault (E037)		
F09.30	Frequency upon current fault	-	-	●
F09.31	Output current upon current fault	-	-	●
F09.32	Bus voltage upon current fault	-	-	●
F09.33	Input terminal status upon current fault	-	-	●
F09.34	Output terminal status upon current fault	-	-	●
F09.35	AC drive status upon current fault	-	-	●
F09.36	Power-on time status upon current fault	-	-	●
F09.37	Running time status upon current fault	-	-	●
F09.38	Frequency upon 2nd fault	-	-	●
F09.39	Output current upon 2nd fault	-	-	●

Function code	Name	Description(setting range)	Factory Default	Change
F09.40	Bus voltage upon 2nd fault	-	-	●
F09.41	Input terminal status upon 2nd fault	-	-	●
F09.42	Output terminal status upon 2nd fault	-	-	●
F09.43	AC drive status upon 2nd fault	-	-	●
F09.44	Power-on time upon 2nd fault	-	-	●
F09.45	Running time upon 2nd fault	-	-	●
F09.46	Frequency upon 1st fault	-	-	●
F09.47	Output current upon 1st fault	-	-	●
F09.48	Bus voltage upon 1st fault	-	-	●
F09.49	Input terminal status upon 1st fault	-	-	●
F09.50	Output terminal status upon 1st fault	-	-	●
F09.51	AC drive status upon 1st fault	-	-	●
F09.52	Power-on time upon 1st fault	-	-	●
F09.53	Running time upon 1st fault	-	-	●
F09.54	Short-circuit to ground upon power-on	0: Disabled 1: Enabled	1	※
F09.55	Output terminal action during fault auto reset	0: Not act 1: Act	0	※
F09.56	Backup frequency upon abnormality	0.0%~100.0% (100.0% corresponding to maximum frequency)F00.03)	100.0%	※
F09.57	Type of motor temperature sensor	0: No temperature sensor 1: PT100 2: PT1000	0	※
F09.58	Motor overheat protection threshold	0℃~200℃	110℃	※
F09.59	Motor overheat warning threshold	0℃~200℃	90℃	※
F09.60	Action pause judging voltage at instantaneous power failure	F09.04~100.0%	90.0%	※
F09.61	Starting voltage of brake unit	200V~2000V	Model dependent	※

Function code	Name	Description(setting range)	Factory Default	Change
Group F10: Process Control PID Function				
F10.00	PID setting source	0: Keypad (F10.01) 1: Analog AI1 2: Analog AI2 3: Analog AI3 4: Pulse setting (HDI) 5: Rs485 communication setting 6: Multi-speed command	0	※
F10.01	PID digital setting	0.0~100.0%	50.0%	※
F10.02	PID feedback source	0: AI1 1: AI2 2: AI3 3: AI1 – AI2 4: Pulse setting (HDI) 5: Rs485 communication setting 6: AI1 + AI2 7: MAX (AI1 , AI2) 8: MIN (AI1 , AI2)	0	※
F10.03	PID output characteristic	0 : positive 1 : negative	0	※
F10.04	PID setting feedback range	0~65535	1000	※
F10.05	Proportional gain Kp1	0.0~100.0	20.0	※
F10.06	Integral time Ti1	0.01s~10.00s	2.00s	※
F10.07	Differential time Td1	0.000s~10.000s	0.000s	※
F10.08	Cut-off frequency of PID reverse rotation	0.00~F00.03 (maximum frequency)	0.00Hz	※
F10.09	PID deviation limit	0.0%~100.0%	0.0%	※
F10.10	PID differential limit	0.00%~100.00%	0.10%	※
F10.11	PID setting change time	0.00~650.00s	0.00s	※
F10.12	PID feedback filter time	0.00~60.00s	0.00s	※
F10.13	PID output filter time	0.00~60.00s	0.00s	※
F10.15	Proportional gain Kp2	0.0~100.0	20.0	※

Function code	Name	Description(setting range)	Factory Default	Change
F10.16	Integral time Ti2	0.01s~10.00s	2.00s	※
F10.17	Differential time Td2	0.000s~10.000s	0.000s	※
F10.18	PID parameter switch over condition	0: No switch over 1: Switch over via input terminal 2: Automatic switch over based on deviation	0	※
F10.19	PID parameter switch over deviation 1	0.0%~F10.20	20.0%	※
F10.20	PID parameter switch over deviation 2	F10.19~100.0%	80.0%	※
F10.21	PID initial value	0.0%~100.0%	0.0%	※
F10.22	PID initial value holding time	0.00~650.00s	0.00s	※
F10.23	Maximum deviation between two PID outputs in forward direction	0.00%~100.00%	1.00%	※
F10.24	Maximum deviation between two PID outputs in reverse direction	0.00%~100.00%	1.00%	※
F10.25	PID integral property	Unit's digit : Integral separated 0: Invalid 1: Valid Ten's digit : Whether to stop integral operation when the output reaches the limit 0: Continue integral operation 1: Stop integral operation	00	※
F10.26	Detection value of PID feedback loss	0.0%: Not judging feedback loss 0.1%~100.0%	0.0%	※
F10.27	Detection time of PID feedback loss	0.0s~20.0s	0.0s	※
F10.28	PID operation at stop	0: No PID operation at stop 1: PID operation at stop	1	※

Function code	Name	Description(setting range)	Factory Default	Change
Group F11: Swing Frequency, Fixed Length and Count				
F11.00	Swing frequency setting mode	0: Relative to the central frequency 1: Relative to the maximum frequency	0	※
F11.01	Swing frequency amplitude	0.0%~100.0%	0.0%	※
F11.02	Jump frequency amplitude	0.0%~50.0%	0.0%	※
F11.03	Swing frequency cycle	0.1s~3000.0s	10.0s	※
F11.04	Triangular wave rising time coefficient	0.1%~100.0%	50.0%	※
F11.05	Set length	0m~65535m	1000m	※
F11.06	Actual length	0m~65535m	0m	※
F11.07	Number of pulses per meter	0.1~6553.5	100.0	※
F11.08	Set count value	1~65535	1000	※
F11.09	Designated count value	1~65535	1000	※
Group F12: Simple PLC Function And Multi-speed control				
F12.00	Simple PLC running mode	0: Stop after the AC drive runs one cycle 1: Keep final values after the AC drive runs one cycle 2: Repeat after the AC drive runs one cycle	0	※
F12.01	Simple PLC retentive selection	Unit's digit :Retentive upon power failure 0: No 1: Yes Ten's digit :Retentive upon stop 0: No 1: Yes	00	※
F12.02	Multi-speed 0	-100.0%~100.0%	0.0%	※
F12.03	Multi-speed 1	-100.0%~100.0%	0.0%	※
F12.04	Multi-speed 2	-100.0%~100.0%	0.0%	※
F12.05	Multi-speed 3	-100.0%~100.0%	0.0%	※
F12.06	Multi-speed 4	-100.0%~100.0%	0.0%	※
F12.07	Multi-speed 5	-100.0%~100.0%	0.0%	※
F12.08	Multi-speed 6	-100.0%~100.0%	0.0%	※
F12.09	Multi-speed 7	-100.0%~100.0%	0.0%	※

Function code	Name	Description(setting range)	Factory Default	Change
F12.10	Multi-speed 8	-100.0%~100.0%	0.0%	※
F12.11	Multi-speed 9	-100.0%~100.0%	0.0%	※
F12.12	Multi-speed 10	-100.0%~100.0%	0.0%	※
F12.13	Multi-speed 11	-100.0%~100.0%	0.0%	※
F12.14	Multi-speed 12	-100.0%~100.0%	0.0%	※
F12.15	Multi-speed 13	-100.0%~100.0%	0.0%	※
F12.16	Multi-speed 14	-100.0%~100.0%	0.0%	※
F12.17	Multi-speed 15	-100.0%~100.0%	0.0%	※
F12.18	Running time of simple PLC multi-speed 0	0.0s(h)~6500.0s(h)	0.0s(h)	※
F12.19	Acceleration/deceleration time of simple PLC multi-speed 0	0~3	0	※
F12.20	Running time of simple PLC multi-speed 1	0.0s(h)~6500.0s(h)	0.0s(h)	※
F12.21	Acceleration/deceleration time of simple PLC multi-speed 1	0~3	0	※
F12.22	Running time of simple PLC multi-speed 2	0.0s(h)~6500.0s(h)	0.0s(h)	※
F12.23	Acceleration/deceleration time of simple PLC multi-speed 2	0~3	0	※
F12.24	Running time of simple PLC multi-speed 3	0.0s(h)~6500.0s(h)	0.0s(h)	※
F12.25	Acceleration/deceleration time of simple PLC multi-speed 3	0~3	0	※
F12.26	Running time of simple PLC multi-speed 4	0.0s(h)~6500.0s(h)	0.0s(h)	※
F12.27	Acceleration/deceleration time of simple PLC multi-speed 4	0~3	0	※
F12.28	Running time of simple PLC multi-speed 5	0.0s(h)~6500.0s(h)	0.0s(h)	※
F12.29	Acceleration/deceleration time of simple PLC multi-speed 5	0~3	0	※
F12.30	Running time of simple PLC multi-speed 6	0.0s(h)~6500.0s(h)	0.0s(h)	※
F12.31	Acceleration/deceleration time of simple PLC multi-speed 6	0~3	0	※
F12.32	Running time of simple PLC multi-speed 7	0.0s(h)~6500.0s(h)	0.0s(h)	※

Function code	Name	Description(setting range)	Factory Default	Change
F12.33	Acceleration/deceleration time of simple PLC multi-speed 7	0~3	0	※
F12.34	Running time of simple PLC multi-speed 8	0.0s(h)~6500.0s(h)	0.0s(h)	※
F12.35	Acceleration/deceleration time of simple PLC multi-speed 8	0~3	0	※
F12.36	Running time of simple PLC multi-speed 9	0.0s(h)~6500.0s(h)	0.0s(h)	※
F12.37	Acceleration/deceleration time of simple PLC multi-speed 9	0~3	0	※
F12.38	Running time of simple PLC multi-speed 10	0.0s(h)~6500.0s(h)	0.0s(h)	※
F12.39	Acceleration/deceleration time of simple PLC multi-speed 10	0~3	0	※
F12.40	Running time of simple PLC multi-speed 11	0.0s(h)~6500.0s(h)	0.0s(h)	※
F12.41	Acceleration/deceleration time of simple PLC multi-speed 11	0~3	0	※
F12.42	Running time of simple PLC multi-speed 12	0.0s(h)~6500.0s(h)	0.0s(h)	※
F12.43	Acceleration/deceleration time of simple PLC multi-speed 12	0~3	0	※
F12.44	Running time of simple PLC multi-speed 13	0.0s(h)~6500.0s(h)	0.0s(h)	※
F12.45	Acceleration/deceleration time of simple PLC multi-speed 13	0~3	0	※
F12.46	Running time of simple PLC multi-speed 14	0.0s(h)~6500.0s(h)	0.0s(h)	※
F12.47	Acceleration/deceleration time of simple PLC multi-speed 14	0~3	0	※
F12.48	Running time of simple PLC multi-speed 15	0.0s(h)~6500.0s(h)	0.0s(h)	※
F12.49	Acceleration/deceleration time of simple PLC multi-speed 15	0~3	0	※
F12.50	Time unit of multi-speed	0: s (second) 1: h (hour)	0	※

Function code	Name	Description(setting range)	Factory Default	Change
F12.51	Multi-speed 0 source	0: Set by F12.02 1: AI1 2: AI2 3: AI3 4: Pulse setting 5: PID 6: Set frequency via keypad (F00.10), modified UP/DOWN	0	※
Group F13: Communication Parameters				
F13.00	Local address	1~247, 0 is broadcast address	1	※
F13.01	Baud rate	0: 300BPS 1: 600BPS 2: 1200BPS 3: 2400BPS 4: 4800BPS 5: 9600BPS 6: 19200BPS 7: 38400BPS 8: 57600BPS 9: 115200BPS	5	※
F13.02	Data format	0: No check, data format (8,N,2) 1: Even parity check, data format (8,E,1) 2: Odd Parity check, data format (8,O,1) 3: Data format (8,N,1)	3	※
F13.03	Response delay	0ms~20ms	20	※
F13.04	Communication timeout	0.0 (invalid) , 0.1s~60.0s	0.0	※
F13.05	Modbus protocol selection	0: Non-standard Modbus protocol 1: Standard Modbus protocol	1	※
F13.06	Communication reading current resolution	0: 0.01A 1: 0.1A	0	※

Function code	Name	Description(setting range)	Factory Default	Change
Group F15: Motor 2 Parameters				
F15.00	Motor type selection	0: Common asynchronous motor 1: Variable frequency asynchronous motor	0	●
F15.01	Rated motor power	0.1kW~1000.0kW	Model dependent	●
F15.02	Rated motor frequency	0.01Hz~F00.03(maximum frequency)	Model dependent	●
F15.03	Rated motor rotational speed	1rpm~65535rpm	Model dependent	●
F15.04	Rated motor voltage	1V~2000V	Model dependent	●
F15.05	Rated motor current	0.01A~655.35A (AC drive power ≤ 55kW) 0.1A~6553.5A (AC drive power > 55kW)	Model dependent	●
F15.06	Stator resistance	0.001Ω~65.535Ω (AC drive power ≤ 55kW) 0.0001Ω~6.5535Ω (AC drive power > 55kW)	Model dependent	●
F15.07	Rotor resistance	0.001Ω~65.535Ω (AC drive power ≤ 55kW) 0.0001Ω~6.5535Ω (AC drive power > 55kW)	Model dependent	●
F15.08	Leakage inductive reactance	0.01mH~655.35mH (AC drive power ≤ 55kW) 0.001mH~65.535mH (AC drive power > 55kW)	Model dependent	●
F15.09	Mutual inductive reactance	0.1mH~6553.5mH (AC drive power ≤ 55kW) 0.01mH~655.35mH (AC drive power > 55kW)	Model dependent	●
F15.10	No-load current	0.01A~F15.05 (AC drive power ≤ 55kW) 0.1A~F15.05 (AC drive power > 55kW)	Model dependent	●

Function code	Name	Description(setting range)	Factory Default	Change
F15.27	Encoder type	0: ABZ incremental encoder 1: UVW incremental encoder	0	●
F15.28	PG card selection	0: QEPI	0	●
F15.29	Encoder pulses per revolution	1~65535	2500	●
F15.30	A, B phase sequence of ABZ incremental encoder	0: Forward 1: Reverse	0	●
F15.31	Encoder installation angle	0.0~359.9°	0.0°	●
F15.32	U, V, W phase sequence of UVW encoder	0: Forward 1: Reverse	0	●
F15.33	UVW encoder angle offset	0.0~359.9°	0.0°	●
F15.36	Encoder wire-break fault detection time	0.0: no action 0.1s~10.0s	0.0	●
F15.37	Self-learning selection	0: No self-learning 1: Asynchronous motor static self-learning 2: Asynchronous motor dynamic self-learning	0	●
F15.38	Speed loop proportional gain 1	1~100	30	※
F15.39	Speed loop integral time 1	0.01s~10.00s	0.50s	※
F15.40	Switch over frequency 1	0.00~F15.43	5.00Hz	※
F15.41	Speed loop proportional gain 2	1~100	20	※
F15.42	Speed loop integral time 2	0.01s~10.00s	1.00s	※
F15.43	Switch over frequency 2	F15.40~F00.03(maximum frequency)	10.00Hz	※
F15.44	Vector control slip gain	50%~200%	100%	※
F15.45	Time constant of speed loop filter	0.000s~0.100s	0.000s	※
F15.46	Vector control overexcitation gain	0~200	64	※

Function code	Name	Description(setting range)	Factory Default	Change
F15.47	Torque upper limit source in speed control mode	0: F15.48 1: AI1 2: AI2 3: AI3 4: Pulse setting (HDI) 5: Rs485 communication 6: MIN(AI1,AI2) 7: MIN(AI1,AI2)	0	※
F15.48	Digital setting of torque upper limit in speed control mode	0.0%~200.0%	150.0%	※
F15.51	Excitation adjustment proportional gain	0~60000	2000	※
F15.52	Excitation adjustment integral gain	0~60000	1300	※
F15.53	Torque adjustment proportional gain	0~60000	2000	※
F15.54	Torque adjustment integral gain	0~60000	1300	※
F15.55	Speed loop integral property	Unit's digit: Integral separated 0: Disabled 1: Enabled	0	※
F15.61	Motor 2 control mode	0: non-PG vector control 1: PG vector control 2: V/F control	0	●
F15.62	Motor 2 acceleration/ deceleration time	0: Same as motor 1 1: Acceleration/Deceleration time 1 2: Acceleration/Deceleration time 2 3: Acceleration/Deceleration time 3 4: Acceleration/Deceleration time 4	0	※
F15.63	Motor 2 torque boost	0.0%: Automatic torque boost 0.1%~30.0%	Model dependent	※
F15.65	Motor 2 oscillation suppression gain	0~100	Model dependent	※

Chapter 6 Description of Function Codes

Group F00: Standard Function Parameters

Function Code	Parameter Name	Setting Range	Default
F00.00	Speed control mode	0: non-PG vector control (SVC) 1: PG vector control (FVC) 2: V/F control	2

0: : non-PG vector control (SVC)

It indicates open-loop vector control, and is applicable to high-performance control applications without encoder such as machine tool, centrifuge, wire drawing machine and injection molding machine. One AC drive can operate only one motor.

1: PG vector control (FVC)

It is applicable to high-accuracy speed control or torque control applications such as high-speed paper making machine, crane and elevator. One AC drive can operate only one motor. An encoder must be installed at the motor side, and a PG card matching the encoder must be installed at the AC drive side.

2: V/F control

It is applicable to applications with low load requirements or applications where one AC drive operates multiple motors, such as fan and pump.

Note: If vector control is used, motor self-learning must be performed because the advantages of vector control can only be utilized after correct motor parameters are obtained. Better performance can be achieved by adjusting speed regulator parameters in group F03 (or groups F15 for motor 2)

Function Code	Parameter Name	Setting Range	Default
F00.01	Command source selection	0: keypad control 1: terminal control 2: RS 485 communication control	0

It is used to determine the input channel of the AC drive control commands, such as run, stop, forward rotation, reverse rotation and jog operation. You can input the commands in the following three channels:

0: keypad control

Commands are given by pressing keys RUN, STOP/RES on the keypad

1: terminal control

Commands are given by means of multifunctional input terminals with functions such as FWD, REV, forward JOG, and reverse JOG

2: RS 485 communication control

Commands are given from host computer. Refer to Group F13: Communication Parameters for parameters

Function Code	Parameter Name	Setting Range	Default
F00.03	Max.output frequency	50.00Hz~600.00Hz	50.00Hz

It is used to set the maximum output frequency of the inverter. It is the basis of the frequency setting, as well as the foundation of acceleration and deceleration speed. Please pay attention.

When analog input,pulse input(HDI),multiple command as frequency source of AC, it 100% corresponding to F00.03.

Function Code	Parameter Name	Setting Range	Default
F00.04	Run frequency upper limit	F00.05 ~ F00.03(max.frequency)	50.00Hz

Upper limit of the inverter's output frequency. The value should be less than or equal to the maximum output frequency.

Function Code	Parameter Name	Setting Range	Default
F00.05	Run frequency lower limit	0.00Hz~ F00.04 (run frequency upper limit)	00.00Hz

Lower limit of the inverter's output frequency.

When the set frequency is lower than the lower limit frequency:When the starting set frequency is lower than the lower limit of frequency, it can not be started.When the set frequency entering the running frequency is lower than the lower limit frequency, AC drive can stop,run as frequency lower limit or zero speed via F08.14

Function Code	Parameter Name	Setting Range	Default
F00.06	Frequency A command selection	0:keypad,non-retentive at power failure 1:keypad, retentive at power failure 2:analog AI1 3:analog AI2 4:analog AI3 5:pulse (HDI) 6:multi-speed running 7:simple PLC 8:PID control 9:RS485 Communication 10:potentiometer	0

It is used to select the setting channel of the main frequency. You can set the main frequency in the following 10 channels:

- 0:keypad,non-retentive at power failure

The initial value of the set frequency is the value of F00.10 (Preset frequency). You can change the set frequency by pressing \wedge and \vee on the operation panel (or using the UP/DOWN function of input terminals).

When the AC drive is powered on again after power failure, the set frequency reverts to the value of F00.10.

- 1: keypad,retentive at power failure

The initial value of the set frequency is the value of F00.10 (Preset frequency). You can change the set frequency by pressing keys \wedge and \vee on the operation panel (or using the UP/DOWN function of input terminals).

When the AC drive is powered on again after power failure, the set frequency is the value memorized at the moment of the last power failure.

Note that F00.26 (Retentive of digital setting frequency upon power failure) determines whether the set frequency is memorized or cleared when the AC drive stops. It is related to stop rather than power failure.

- 2: AI1 (0–10 V voltage input or 0–20 mA current input, determined by jumper)
- 3: AI2 (0–10 V voltage input or 0–20 mA current input, determined by jumper)
- 4: AI3 (-10–10 V voltage input)

The frequency is set by analog input. The control board provides three analog input (AI) terminals (AI1, AI2).

The drive provides five curves indicating the mapping relationship between the input voltage of AI1, AI2 and AI3 and the target frequency, three of which are linear (pointpoint) correspondence and two of which are four-point correspondence curves. You can set the curves by using function codes F05 ,and select curves for AI1, AI2 and AI3 in F05.38. When AI is used as the frequency setting source, the corresponding value 100% of the voltage/current input corresponds to the value of F05.

- 5: Pulse setting (HDI)

The frequency is set by HDI (high-speed pulse). The signal specification of pulse setting is 9–26 V (voltage range) and 0–100 kHz (frequency range). The corresponding value 100% of pulse setting corresponds to the value of F00.03 (Maximum frequency).

- 6: Multi-reference

In multi-reference mode, combinations of different input terminal states correspond to different set frequencies by setting F05 and F12. The drive supports a maximum of 16 speeds implemented by 16 state combinations of four terminals in Group F12. The multiple references indicate percentages of the value of F00.03 (Maximum frequency).

If a S terminal is used for the multi-reference function, you need to perform related setting in group F05.

- 7: Simple PLC

When the simple programmable logic controller (PLC) mode is used as the frequency source, the running frequency of the AC drive can be switched over among the 16 frequency references. You can set the holding time and acceleration/deceleration time of the 16 frequency references. For details, refer to the descriptions of Group F12.

• 8: PID

The output of PID control is used as the running frequency. PID control is generally used in on-site closed-loop control, such as constant pressure closed-loop control and constant tension closed-loop control.

When applying PID as the frequency source, you need to set parameters of PID function in group F10.

• 9: Communication setting

The main frequency source is set by means of communication.

For details, see the description of Appendix A Serial Communications

• 10: Potentiometer

The frequency is set by potentiometer.

Function Code	Parameter Name	Setting Range	Default
F00.07	Frequency B command selection	same as F00.06	0

When used as an independent frequency input channel (frequency source switched over from A to B), the auxiliary frequency source B is used in the same way as the main frequency source A (refer to F00.06).

When the auxiliary frequency source is used for operation (frequency source is "A + B operation"), pay attention to the following aspects:

1) If the auxiliary frequency source B is keypad setting, the preset frequency (F00.10) does not take effect. You can directly adjust the set main frequency by pressing keys \wedge and \vee on the operation panel (or using the UP/DOWN function of input terminals).

2) If the auxiliary frequency source B is analog input (AI1, AI2 and AI3) or pulse setting, 100% of the input corresponds to the range of the auxiliary frequency B (set in F00.08 and F00.25).

3) If the auxiliary frequency source B is pulse setting, it is similar to analog input.

NOTE: The main frequency source A and auxiliary frequency source B must not use the same channel. That is, F00.06 and F00.07 cannot be set to the same value.

Function Code	Parameter Name	Setting Range	Default
F00.08	Range of command selection frequency B	0: relative to maximum frequency 1: relative to frequency A command	0

You can set the auxiliary frequency to be relative to either maximum frequency or main frequency A. If relative to main frequency A, the setting range of the auxiliary frequency B varies according to the main frequency A.

Function Code	Parameter Name	Setting Range	Default
F00.09	Frequency source combination mode	0: frequency A command 1: frequency B command 2: switch over between A and B 3: A+B 4: A-B 5: MAX (A and B) 6: MIN (A and B)	0

It is used to select the frequency setting channel. If the frequency source involves A and B operation, you can set the frequency offset in F00.25 for superposition to the A and B operation result, flexibly satisfying various requirements..

0: Frequency A command
Frequency A as target frequency

1: Frequency B command
Frequency B as target frequency

2: Switch over between frequency A command and frequency B command
If multi-function input terminal 18 is invalid, frequency A is target frequency; If multi-function input terminal 18 is valid, frequency B is target frequency.

3: A+B
It's frequency superposition that both A and B as target frequency.

4: A-B
Target frequency is difference value of A-B.

5: MAX (A and B)
Target frequency is Max.absolute value.

6: MIN (A and B)
Target frequency is Min.absolute value.

Function Code	Parameter Name	Setting Range	Default
F00.10	Keypad setting frequency	0.00Hz ~ F00.03 (max.frequency)	50.00Hz

If the frequency source is Keypad setting or terminal UP/DOWN, the value of this parameter is the initial frequency of the AC drive (digital setting).

Function Code	Parameter Name	Setting Range	Default
F00.11	Frequency reference resolution	1: 0.1Hz 2: 0.01Hz	2

It is used to set the resolution of all frequency-related parameters.
If the resolution is 0.1 Hz, the drive can output up to 600.0 Hz.
If the resolution is 0.01 Hz, the drive can output up to 300.0 Hz.

Function Code	Parameter Name	Setting Range	Default
F00.12	Acceleration time 1	0.00s ~ 6500.0s	Model dependent
F00.13	Deceleration time 1	0.00s ~ 6500.0s	Model dependent

Acceleration time indicates the time required by the AC drive to accelerate from 0 Hz to "Acceleration/Deceleration base frequency" (F00.15), that is, t1 in Figure 6-1.
 Deceleration time indicates the time required by the AC drive to decelerate from "Acceleration/Deceleration base frequency" (F00.15) to 0 Hz, that is, t2 in Figure 6-1.

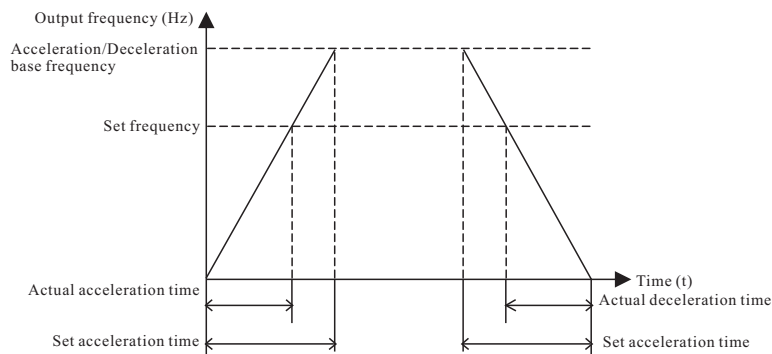

Figure 6-1 Acceleration/Deceleration time

The drive provides totally four groups of acceleration/deceleration time for selection. You can perform switch over by using a DI terminal.

- Group 1: F00.12, F00.13
- Group 2: F08.00, F08.01
- Group 3: F08.02, F08.03
- Group 4: F08.04, F08.05

Function Code	Parameter Name	Setting Range	Default
F00.14	Acceleration/Deceleration time unit	0:1s 1: 0.1s 2: 0.01s	1

To satisfy requirements of different applications, the drive provides three acceleration/deceleration time units, 1s, 0.1s and 0.01s.

Function Code	Parameter Name	Setting Range	Default
F00.15	Acceleration/Deceleration time base frequency	0:max.frequency (F00.03) 1:setting frequency 2:100Hz	0

The acceleration/deceleration time indicates the time for the AC drive to increase from 0 Hz to the frequency set in F00.15. If this parameter is set to 1, the acceleration/deceleration time is related to the set frequency. If the set frequency changes frequently, the motor's acceleration/deceleration also changes.

Function Code	Parameter Name	Setting Range	Default
F00.16	Rotation direction	0: same direction 1: reverse direction	0

You can change the rotation direction of the motor just by modifying this parameter without changing the motor wiring. Modifying this parameter is equivalent to exchanging any two of the motor's U, V, W wires.

Note: The motor will resume running in the original direction after parameter initialization. Do not use this function in applications where changing the rotating direction of the motor is prohibited after system commissioning is complete.

Function Code	Parameter Name	Setting Range	Default
F00.17	Carrier frequency	0.5kHz~8.0kHz	Model dependent

Carrier frequency	Motor noise	Leakage current	AC drive temperature rise
0.5kHz	↑ Large	↑ Small	↑ Low
8kHz	↓ Small	↓ Large	↓ High

Relationship between model and carrier frequency

Carrier frequency	Highest carrier frequency (kHz)	Lowest carrier frequency (kHz)	Default (kHz)
Model			
G model: 0.75kW~11kW P model: 0.75kW~15kW	8	0.5	6
G model: 15kW~45kW P model: 18.5kW~55kW	8	0.5	4
G model: 55kW P model: 75kW	8	0.5	3
G model: 75kW~315kW P model: 93kW~350kW	8	0.5	2

The factory setting of carrier frequency varies with the AC drive power. If you need to modify the carrier frequency, note that if the set carrier frequency is higher than factory setting, it will lead to an increase in temperature rise of the AC drive's heatsink. In this case, you need to de-rate the AC drive. Otherwise, the AC drive may overheat and alarm. No need to modify this parameter in general.

Function Code	Parameter Name	Setting Range	Default
F00.18	Carrier frequency adjustment with temperature	0: No 1: Yes	1

It is used to set whether the carrier frequency is adjusted based on the temperature. The AC drive automatically reduces the carrier frequency when detecting that the heatsink temperature is high. The AC drive resumes the carrier frequency to the set value when the heatsink temperature becomes normal. This function reduces the overheat alarms.

Function Code	Parameter Name	Setting Range	Default
F00.19	Source of frequency upper limit	0: set by F00.04 1: analog AI1 2: analog AI2 3: analog AI3 4: pulse (HDI) 5: RS485 communication	0

It is used to set the source of the frequency upper limit, including digital setting (F00.04), AI, pulse setting or communication setting. If the frequency upper limit is set by means of AI1, AI2, AI3, DI5 or communication, the setting is similar to that of frequency A command. For details, see the description of F00.04.

For example, to avoid runaway in torque control mode in winding application, you can set the frequency upper limit by means of analog input. When the AC drive reaches the upper limit, it will continue to run at this speed.

Function Code	Parameter Name	Setting Range	Default
F00.20	Frequency upper limit offset	0.00Hz ~ max. frequency (F00.03)	00.00Hz

If the source of the frequency upper limit is analog input or pulse setting, the final frequency upper limit is obtained by adding the offset in this parameter to the frequency upper limit set in F00.19.

Function Code	Parameter Name	Setting Range	Default
F00.21	Base frequency for UP/DOWN modification during running	0: running frequency 1: set frequency	0

This parameter is valid only when the frequency source is digital setting.

It is used to set the base frequency to be modified by using keys \wedge / \vee or the terminal UP/DOWN function. If the running frequency and set frequency are different, there will be a large difference between the AC drive's performance during the acceleration/ deceleration process.

Function Code	Parameter Name	Setting Range	Default
F00.22	Binding command source to frequency source	Unit digit: Binding keypad command to frequency source 0: no binding 1: keypad setting 2: analog AI1 3: analog AI2 4: analog AI3 5: pulse setting (HDI) 6: multi-speed run setting 7: Simple PLC 8: PID control 9: RS485 communication Ten's digit: Binding terminal command to frequency source Hundred's digit: Binding communication command to frequency source Thousands digit: Binding auto-operation command to frequency source	0000

It is used to bind the three running command sources with the nine frequency sources, facilitating to implement synchronous switch over.

For details on the frequency sources, see the description of F00.06 (frequency A command selection).

Different running command sources can be bound to the same frequency source. If a command source has a bound frequency source, the frequency source set in F00.06 to F00.09 no longer takes effect when the command source is effective.

Function Code	Parameter Name	Setting Range	Default
F00.23	Range of frequency B source during superposition	0% ~ 150%	100%

If X and Y operation is used, F00.09 and F00.08 are used to set the adjustment range of the auxiliary frequency source.

You can set the auxiliary frequency to be relative to either maximum frequency or main frequency A. If relative to main frequency A, the setting range of the auxiliary frequency B varies according to the main frequency A.

Function Code	Parameter Name	Setting Range	Default
F00.25	Frequency offset of frequency B source during superposition	0.00Hz ~ max.frequency F00.03	00.00Hz

If the frequency source involves A and B operation, you can set the frequency offset in F00.25 for superposition to the A and B operation result, flexibly satisfying various requirements.

Function Code	Parameter Name	Setting Range	Default
F00.26	Retentive of keypad setting frequency upon power failure	0: Not retentive 1: Retentive	0

This parameter is valid only when the frequency source is keypad setting.

If F00.26 is set to 0, the keypad setting frequency value resumes to the value of F00.10 (Preset frequency) after the AC drive stops. The modification by using keys \wedge 、 \vee or the terminal UP/DOWN function is cleared.

If F00.26 is set to 1, the keypad setting frequency value is the set frequency at the moment when the AC drive stops. The modification by using keys \wedge 、 \vee or the terminal UP/DOWN function remains effective.

Function Code	Parameter Name	Setting Range	Default
F00.27	Motor model selection	0: G type (constant torque load) 1: P type (variable torque load)	Model dependent

This parameter is used to display the delivered model and cannot be modified.

- 1: Applicable to constant torque load with rated parameters specified
- 2: Applicable to variable torque load (fan and pump) with rated parameters specified

Function Code	Parameter Name	Setting Range	Default
F00.28	Function parameter restore	0:no operation 1: restore factory defaults,not include motor parameter 2: clear fault file	0

Group F01: Start-stop Control Parameters

Function Code	Parameter Name	Setting Range	Default
F01.00	Start mode	0:direct start 1:rotational speed tracking restart (valid on V/F control) 2: pre-excited start	0

- 0: Direct start
- 1: Rotational speed tracking restart (valid on V/F control)

The AC drive judges the rotational speed and direction of the motor first and then starts at the tracked frequency. Such smooth start has no impact on the rotating motor. It is applicable to the restart upon instantaneous power failure of large-inertia load. To ensure the performance of rotational speed tracking restart, set the motor parameters in group F02 correctly.

- 2: Pre-excited start (asynchronous motor)

It is valid only for asynchronous motor and used for building the magnetic field before the motor runs. For pre-excited current and pre-excited time, see parameters of F01.03 and F01.04.

Function Code	Parameter Name	Setting Range	Default
F01.01	Startup frequency	0.00Hz~10.00Hz	0.00Hz
F01.02	Startup frequency holding time	0.0s~100.0s	0.0s

To ensure the motor torque at AC drive startup, set a proper startup frequency. In addition, to build excitation when the motor starts up, the startup frequency must be held for a certain period.

The startup frequency (F01.02) is not restricted by the frequency lower limit. If the set target frequency is lower than the startup frequency, the AC drive will not start and stays in the standby state.

During switch over between forward rotation and reverse rotation, the startup frequency holding time is disabled.

Function Code	Parameter Name	Setting Range	Default
F01.03	Startup DC braking current/ Pre-excited current	0%~100%	50%
F01.04	Startup DC braking time/ Pre-excited time	0.0s~100.0s	0.0s

Startup DC braking is generally used during restart of the AC drive after the rotating motor stops. Pre-excitation is used to make the AC drive build magnetic field for the asynchronous motor before startup to improve the responsiveness.

Startup DC braking is valid only for direct start (F01.00=0). In this case, the AC drive performs DC braking at the set startup DC braking current. After the startup DC braking time, the AC drive starts to run. If the startup DC braking time is 0, the AC drive starts directly without DC braking. The larger the startup DC braking current is, the larger the braking force is.

If the startup mode is pre-excited start (F01.00 = 2), the AC drive builds magnetic field based on the set pre-excited current. After the pre-excited time, the AC drive starts to run. If the pre-excited time is 0, the AC drive starts directly without pre-excitation.

The startup DC braking current or pre-excited current is a percentage relative to the base value.

Function Code	Parameter Name	Setting Range	Default
F01.05	Acceleration/ deceleration mode	0: line Acc/Dec time 1:S curve A 2:S curve Acc/Dec B Acc/Dec	0

It is used to set the frequency change mode during the AC drive start and stop process.

• 0: Linear acceleration/deceleration

The output frequency increases or decreases in linear mode. The AC provides four group of acceleration/deceleration time, which can be selected by using F05.00 to F5.08.

• 1: S-curve acceleration/deceleration A

The output frequency increases or decreases along the S curve. This mode is generally used in the applications where start and stop processes are relatively smooth, such as elevator and conveyor belt. F01.06 and F01.07 respectively define the time proportions of the start segment and the end segment.

• 2: S-curve acceleration/deceleration B

In this curve, the rated motor frequency f_b is always the inflexion point. This mode is usually used in applications where acceleration/deceleration is required at the speed higher than the rated frequency.

When the set frequency is higher than the rated frequency, the acceleration/ deceleration time is:

$$t = (4/9 * (f/f_b)^2 + 5/9) * T$$

In the formula, f is the set frequency, f_b is the rated motor frequency and T is the acceleration time from 0 Hz to f_b .

Function Code	Parameter Name	Setting Range	Default
F01.06	Time proportion of S-curve start segment	0.0%~ (100.0%-F01.07)	30.0%
F01.07	Time proportion of S-curve end segment	0.0%~ (100.0%-F01.06)	30.0%

These two parameters respectively define the time proportions of the start segment and the end segment of S-curve acceleration/deceleration. They must satisfy the requirement:

$$F01.06 + F01.07 \leq 100.0\%$$

In Figure 6-2, t_1 is the time defined in F6-08, within which the slope of the output frequency change increases gradually. t_2 is the time defined in F01.07, within which the slope of the output frequency change gradually decreases to 0. Within the time between t_1 and t_2 , the slope of the output frequency change remains unchanged, that is, linear acceleration/deceleration.

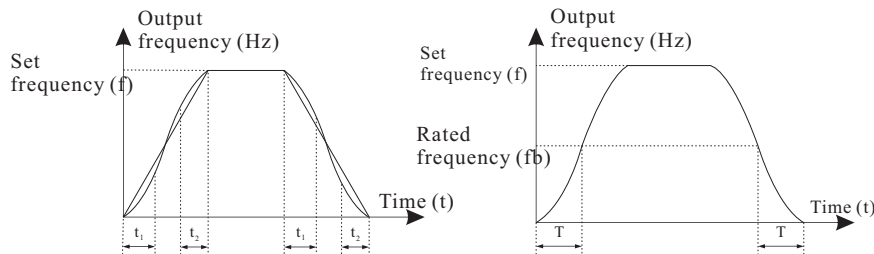

Figure 6-2 S-curve acceleration/deceleration A

Figure 6-3 S-curve acceleration/deceleration B

Function Code	Parameter Name	Setting Range	Default
F01.08	Stop mode	0: deceleration to stop 1: stop freely	0

• 0: Decelerate to stop

After the stop command is enabled, the AC drive decreases the output frequency according to the deceleration time and stops when the frequency decreases to zero.

• 1: Coast to stop

After the stop command is enabled, the AC drive immediately stops the output. The motor will coast to stop based on the mechanical inertia.

Function Code	Parameter Name	Setting Range	Default
F01.09	Initial frequency of stop DC braking	0.00Hz~ F00.03(max. frequency)	0.00Hz
F01.10	Waiting time of stop DC braking	0.0s~100.0s	0.0s
F01.11	Stop DC braking current	0%~100%	50%
F01.12	Stop DC braking time	0.0s~100.0s	0.0s

During the process of decelerating to stop, the AC drive starts DC braking when the running frequency is lower than the value.

When the running frequency decreases to the initial frequency of stop DC braking, the AC drive stops output for a certain period and then starts DC braking. This prevents faults such as overcurrent caused due to DC braking at high speed.

This parameter specifies the output current at DC braking and is a percentage relative to the base value. The larger current, the effect of DC brake is higher, and heat of motor and AC drive is higher.

This parameter specifies the holding time of DC braking. If it is set to 0, DC braking is cancelled.

The stop DC braking process is shown in the following figure 6-4

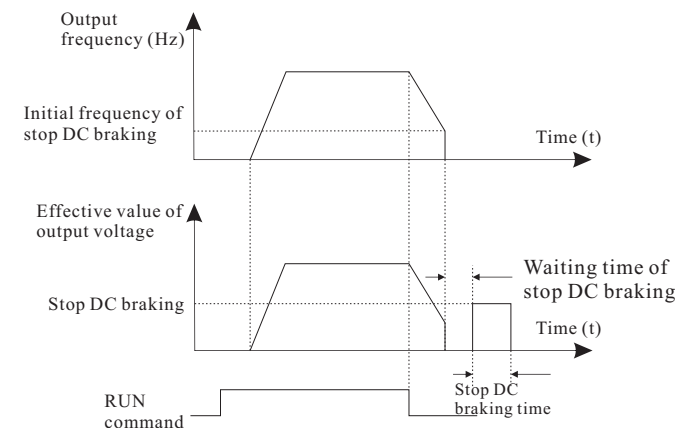

Figure 6-4 The stop DC braking process

Function Code	Parameter Name	Setting Range	Default
F01.13	Rotational speed tracking mode	0: start from frequency at stop 1: start from zero speed 2: start from max. frequency	0

To complete the rotational speed tracking process within the shortest time, select the proper mode in which the AC drive tracks the motor rotational speed.

- 0: From frequency at stop
It is the commonly selected mode.
- 1: From zero frequency
It is applicable to restart after a long time of power failure.
- 2: From the maximum frequency
It is applicable to the power-generating load.

Function Code	Parameter Name	Setting Range	Default
F01.14	Rotational speed tracking speed	1~100	20

In the rotational speed tracking restart mode, select the rotational speed tracking speed. The larger the value is, the faster the tracking is. However, too large value may cause unreliable tracking.

Function Code	Parameter Name	Setting Range	Default
F01.15	Brake usage rate	0%~100%	100%

It is valid only for the AC drive with internal braking unit and used to adjust the duty ratio of the braking unit. The larger the value of this parameter is, the better the braking result will be. However, too larger value causes great fluctuation of the AC drive bus voltage during the braking process.

Group F02: Motor 1 Parameters

Function Code	Parameter Name	Setting Range	Default
F02.00	Motor type selection	0: common asynchronous motor 1: variable frequency asynchronous motor	0
F02.01	Rated power of asynchronous motor 1	0.1kW~1000.0kW	Model dependent
F02.02	Rated frequency of asynchronous motor 1	0.01Hz ~ F00.03(max. frequency)	Model dependent
F02.03	Rated speed of asynchronous motor 1	1rpm~65535rpm	Model dependent
F02.04	Rated voltage of asynchronous motor 1	1V~2000V	Model dependent
F02.05	Rated current of asynchronous motor 1	0.01A ~ 655.35A (AC drive power<=55kW) 0.1A ~ 6553.5A (AC drive power>55kW)	Model dependent

Set the parameters according to the motor nameplate no matter whether V/F control or vector control is adopted.

To achieve better V/F or vector control performance, motor auto-tuning is required. The motor auto-tuning accuracy depends on the correct setting of motor nameplate parameters.

Function Code	Parameter Name	Setting Range	Default
F02.06	Stator resistance of asynchronous motor 1	0.001Ω~65.535Ω (inverter power<=55kW) 0.0001Ω~6.5535Ω (AC drive power>55kW)	Model dependent
F02.07	Rotor resistance of asynchronous motor 1	0.001Ω~65.535Ω (AC drive power<=55kW) 0.0001Ω~6.5535Ω (AC drive power>55kW)	Model dependent
F02.08	Leakage inductive reactance of asynchronous motor 1	0.01mH~655.35mH (AC drive power<=55kW) 0.001mH~65.535mH (AC drive power>55kW)	Model dependent
F02.09	Mutual inductive reactance of asynchronous motor 1	0.1mH~6553.5mH (inverter power<=55kW) 0.01mH~655.35mH (AC drive power>55kW)	Model dependent

Function Code	Parameter Name	Setting Range	Default
F02.10	No-load current of asynchronous motor 1	0.01A~F02.05 (inverter power<=55kW) 0.1A~F02.05 (AC drive power>55kW)	Model dependent

The parameters in F02.06 to F02.10 are asynchronous motor parameters. These parameters are unavailable on the motor nameplate and are obtained by means of motor self-learning.

Only F02.06 to F02.08 can be obtained through static motor auto-tuning. Through complete motor auto-tuning, encoder phase sequence and current loop PI can be obtained besides the parameters in F02.06 to F02.10.

Each time "Rated motor power" (F02.01) or "Rated motor voltage" (F02.04) is changed, the AC drive automatically restores values of F02.06 to F02.10 to the parameter setting for the common standard asynchronous motor.

If it is impossible to perform motor auto-tuning onsite, manually input the values of these parameters according to data provided by the motor manufacturer.

Function Code	Parameter Name	Setting Range	Default
F02.27	Encoder type	0:ABZ incremental encoder 1:UVW incremental encoder	0

The drive supports two types of encoder.

After installation of the PG card is complete, set this parameter properly based on the actual condition. Otherwise, the AC drive cannot run properly.

Function Code	Parameter Name	Setting Range	Default
F02.29	Encoder pulses per revolution	1~65535	2500

This parameter is used to set the pulses per revolution (PPR) of ABZ or UVW incremental encoder. In CLVC mode, the motor cannot run properly if this parameter is set incorrectly.

Function Code	Parameter Name	Setting Range	Default
F02.30	AB phase sequence of ABZ incremental encoder	0:forward 1:reverse	0

This parameter is valid only for ABZ incremental encoder (F02.27 = 0) and is used to set the A/B phase sequence of the ABZ incremental encoder.

It is valid for both asynchronous motor and synchronous motor. The A/B phase sequence can be obtained through "Asynchronous motor complete self-learning".

Function Code	Parameter Name	Setting Range	Default
F02.31	Encoder installation angle	0.0~359.9°	0.0°
F02.32	UVW phase sequence of UVW encoder	0: Forward 1: Reverse	0
F02.33	UVW encoder angle offset	0.0~359.9°	0.0°

Function Code	Parameter Name	Setting Range	Default
F02.36	Encoder wire-break fault detection time	0.0s: No action 0.1~10.0s	0.0

This parameter is used to set the time that a wire-break fault lasts. If it is set to 0.0s, the AC drive does not detect the encoder wire-break fault. If the duration of the encoder wire-break fault detected by the AC drive exceeds the time set in this parameter, the AC drive reports E026.

Function Code	Parameter Name	Setting Range	Default
F02.37	Self-learning of motor parameter	0: no self-learning 1: static self-learning of asynchronous motor 2: complete self-learning of asynchronous motor	0

• 0: No self-learning

• 1: Static self-learning of asynchronous motor

It is applicable to scenarios where complete self-learning cannot be performed because the asynchronous motor cannot be disconnected from the load.

Before performing static self-learning, properly set the motor type and motor nameplate parameters of F02.00 to F02.05 first. The AC drive will obtain parameters of F02.06 to F02.08 by dynamic self-learning.

• 2: Complete self-learning of asynchronous motor

To perform this type of self-learning, ensure that the motor is disconnected from the load. During the process of complete self-learning, the AC drive performs static self-learning first and then accelerates to 80% of the rated motor frequency within the acceleration time set in F00.12. The AC drive keeps running for a certain period and then decelerates to stop within deceleration time set in F00.13.

Before performing complete self-learning, properly set the motor type, motor nameplate parameters of F02.00 to F02.05, "Encoder type" (F02.27) and "Encoder pulses per revolution" (F02.28) first.

Set this parameter to 2, and press "RUN", the AC drive will obtain motor parameters of F02.06 to F02.10, "A/B phase sequence of ABZ incremental encoder" (F02.30) and vector control current loop PI parameters of F03.13 to F03.16 by complete self-learning. Press "STOP" to stop self-learning.

NOTE: Motor self-learning can be performed only in keypad mode. Function code will turn to 0 after finish self-learning.

Group F03: Vector Control Parameters

Group F03 is valid for vector control, and invalid for V/F control.

Function Code	Parameter Name	Setting Range	Default
F03.00	Proportional gain 1 of speed loop	0~100	30
F03.01	Integral time 1 of speed loop	0.01s~10.00s	0.50s
F03.02	Switch over low point frequency	0.00Hz~F03.05	5.00Hz
F03.03	Proportional gain 2 of speed loop	1~100	20
F03.04	Integral time 2 of speed loop	0.01s~10.00s	1.00s
F03.05	Switch over high point frequency	F03.02 ~ F00.03(max. frequency)	10.00Hz

Speed loop PI parameters vary with running frequencies of the AC drive.

- If the running frequency is less than or equal to "Switch over frequency 1" (F03.02), the speed loop PI parameters are F03.00 and F03.01.
- If the running frequency is equal to or greater than "Switch over frequency 2" (F03.05), the speed loop PI parameters are F03.03 and F04.04.
- If the running frequency is between F03.02 and F03.05, the speed loop PI parameters are obtained from the linear switch over between the two groups of PI parameters.

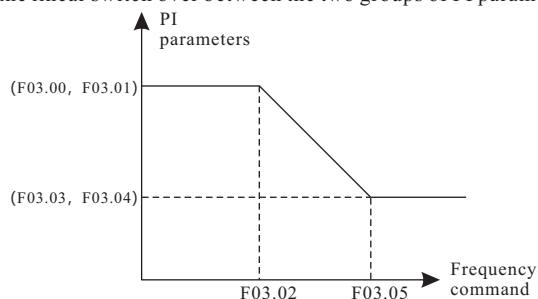

Figure 6-5 Relationship between running frequencies and PI parameters

The speed dynamic response characteristics in vector control can be adjusted by setting the proportional gain and integral time of the speed regulator.

To achieve a faster system response, increase the proportional gain and reduce the integral time. Be aware that this may lead to system oscillation.

The recommended adjustment method is as follows:

If the factory setting cannot meet the requirements, make proper adjustment. Increase the proportional gain first to ensure that the system does not oscillate, and then reduce the integral time to ensure that the system has quick response and small overshoot.

Improper PI parameter setting may cause too large speed overshoot, and overvoltage fault may even occur when the overshoot drops.

Function Code	Parameter Name	Setting Range	Default
F03.06	Vector control slip gain	50%~200%	100%

For SFVC, it is used to adjust speed stability accuracy of the motor. When the motor with load runs at a very low speed, increase the value of this parameter; when the motor with load runs at a very large speed, decrease the value of this parameter.

For CLVC, it is used to adjust the output current of the AC drive with same load.

Function Code	Parameter Name	Setting Range	Default
F03.07	Speed loop output filter	0.000s~0.100s	0.015s

In the vector control mode, the output of the speed loop regulator is torque current reference. This parameter is used to filter the torque references. It need not be adjusted generally and can be increased in the case of large speed fluctuation. In the case of motor oscillation, decrease the value of this parameter properly.

If the value of this parameter is small, the output torque of the AC drive may fluctuate greatly, but the response is quick.

Function Code	Parameter Name	Setting Range	Default
F03.08	Vector control over-excitation gain	0~200	64

During deceleration of the AC drive, over-excitation control can restrain rise of the bus voltage to avoid the overvoltage fault. The larger the over-excitation gain is, the better the restraining effect is.

Increase the over-excitation gain if the AC drive is liable to overvoltage error during deceleration. Too large over-excitation gain, however, may lead to an increase in output current. Therefore, set this parameter to a proper value in actual applications.

Set the over-excitation gain to 0 in applications of small inertia (the bus voltage will not rise during deceleration) or where there is a braking resistor.

Function Code	Parameter Name	Setting Range	Default
F03.09	Torque upper limit source in speed control mode	0:F03.10 1:analog AI1 2:analog AI2 3:analog AI3 4:Pulse(HDI) 5:RS485 Communication 6:MIN(AI1,AI2) 7:MAX(AI1,AI2) (corresponding F03.10 digital setting)	0
F03.10	Digital setting of torque upper limit in speed control mode	0.0%~200.0%	150.0%

In the speed control mode, the maximum output torque of the AC drive is restricted by F03.09. If the torque upper limit is analog, pulse or communication setting, 100% of the setting corresponds to the value of F03.10, and 100% of the value of F03.10 corresponds to the AC drive rated torque.

Function Code	Parameter Name	Setting Range	Default
F03.13	Excitation adjustment proportional gain	0~60000	2000
F03.14	Excitation adjustment integral gain	0~60000	1300
F03.15	Torque adjustment proportional gain	0~60000	2000
F03.16	Torque adjustment integral gain	0~60000	1300

These are current loop PI parameters for vector control. These parameters are automatically obtained through "Asynchronous motor complete self-learning", and need not be modified.
 The dimension of the current loop integral regulator is integral gain rather than integral time.
 Note that too large current loop PI gain may lead to oscillation of the entire control loop.
 Therefore, when current oscillation or torque fluctuation is great, manually decrease the proportional gain or integral gain here.

Function Code	Parameter Name	Setting Range	Default
F03.17	Speed loop integral property	0: invalid 1: valid	0
F03.21	Field weakening automatic adjustment gain	10%~500%	100%
F03.22	Generation power limitation enable	0: invalid 1: full effective 2: constant speed effective 3: deceleration effective	0

The drive provides two field weakening modes: direct calculation and automatic adjustment.

- In direct calculation mode, directly calculate the demagnetized current and manually adjust the demagnetized current by means of F03.19. The smaller the demagnetized current is, the smaller the total output current is. However, the desired field weakening effect may not be achieved.

- In automatic adjustment mode, the best demagnetized current is selected automatically. This may influence the system dynamic performance or cause instability.

The adjustment speed of the field weakening current can be changed by modifying the values of F03.21 and F03.22. A very quick adjustment may cause instability. Therefore, generally do not modify them manually.

Function Code	Parameter Name	Setting Range	Default
F03.23	Speed/torque control mode selection	0: speed control 1: torque control	0

Function Code	Parameter Name	Setting Range	Default
F03.24	Torque setting mode selection	0: digital setting (F03.26) 1: analog AI1 2: analog AI2 3: analog AI3 4: PULSE(HDI) 5: RS485 Communication 6: MIN(AI1, AI2) 7: MAX(AI1, AI2) (corresponding F03.26 digital setting)	0
F03.26	Torque setting by keypad	-200.0%~200.0%	150.0%

If the torque setting mode is 1~7, analog, pulse or communication setting are 100% of the setting corresponds to the value of F03.26.

Function Code	Parameter Name	Setting Range	Default
F03.28	Upper frequency limit of forward when torque control	0.00Hz~F00.03(max.frequency)	50.00Hz
F03.29	Upper frequency limit of reverse when torque control	0.00Hz~F00.03(max.frequency)	50.00Hz

Please limit the max.speed of motor when torque control.

Function Code	Parameter Name	Setting Range	Default
F03.30	Torque control acceleration time	0.00s~650.00s	0.00s
F03.31	Torque control deceleration time	0.00s~650.00s	0.00s

Group F04: V/F Control Parameters

Group F3 is valid only for V/F control.

The V/F control mode is applicable to low load applications (fan or pump) or applications where one AC drive operates multiple motors or there is a large difference between the AC drive power and the motor power.

Function Code	Parameter Name	Setting Range	Default
F04.00	Motor1 V/F curve setting	0:linear V/F 1:multi-point V/F 2:square V/F 3:V/F complete seperation 4:V/F half seperation	0

• 0: Linear V/F

It is applicable to common constant torque load.

• 1: Multi-point V/F

It is applicable to special load such as dehydrator and centrifuge. Any such V/F curve can be obtained by setting parameters of F04.03 to F04.08.

• 2: Square V/F

It is applicable to centrifugal loads such as fan and pump.

• 3: V/F complete separation

In this mode, the output frequency and output voltage of the AC drive are independent. The output frequency is determined by the frequency source, and the output voltage is determined by "Voltage source for V/F separation" (F04.13).

It is applicable to induction heating, inverse power supply and torque motor control.

• 4: V/F half separation

In this mode, V and F are proportional and the proportional relationship can be set in F04.13. The relationship between V and F are also related to the rated motor voltage and rated motor frequency in Group F02.

Assume that the voltage source input is X (0 to 100%), the relationship between V and F is:

$$V/F = 2 * X * (\text{Rated motor voltage}) / (\text{Rated motor frequency})$$

Function Code	Parameter Name	Setting Range	Default
F04.01	Motor 1 torque boost	0.0%:(auto torque boost) 0.1% ~ 30.0%	Model dependent
F04.02	Cut-off frequency of motor 1 torque boost	0.00Hz ~ F00.03(max. frequency)	50.00Hz

To compensate the low frequency torque characteristics of V/F control, you can boost the output voltage of the AC drive at low frequency by modifying F04.02.

If the torque boost is set to too large, the motor may overheat, and the AC drive may suffer overcurrent.

If the load is large and the motor startup torque is insufficient, increase the value of F04.01. If the load is small, decrease the value of F04.01. If it is set to 0.0, the AC drive performs automatic torque boost. In this case, the AC drive automatically calculates the torque boost value based on motor parameters including the stator resistance. F04.02 specifies the frequency under which torque boost is valid. Torque boost becomes invalid when this frequency is exceeded, as shown in the following figure.

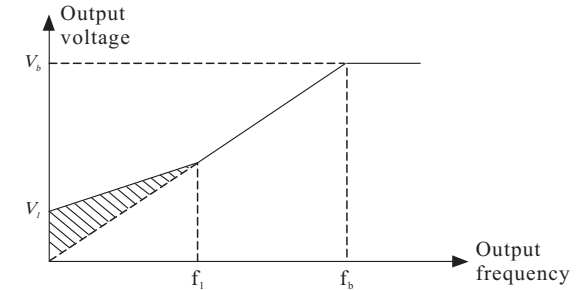

f₁: Cutoff frequency of manual torque boost
f_b: Rated running frequency

Figure 6-4 Manual torque boost

Function Code	Parameter Name	Setting Range	Default
F04.03	Motor1 V/F frequency point 1	0.00Hz~F04.05	0.00Hz
F04.04	Motor1 V/F voltage point 1	0.0%~100%	0.0%
F04.05	Motor1 V/F frequency point 2	F04.03~F04.07	0.00Hz
F04.06	Motor1 V/F voltage point 2	0.0%~100%	0.0%
F04.07	Motor1 V/F frequency point 3	F04.05 ~ F02.02 (motor rated frequency)	0.00Hz
F04.08	Motor1 V/F voltage point 3	0.0%~100%	0.0%

These six parameters are used to define the multi-point V/F curve.

The multi-point V/F curve is set based on the motor's load characteristic. The relationship between voltages and frequencies is:

$$V1 < V2 < V3, \quad f_1 < f_2 < f_3$$

At low frequency, higher voltage may cause overheat or even burnt out of the motor and overcurrent stall or overcurrent protection of the AC drive.

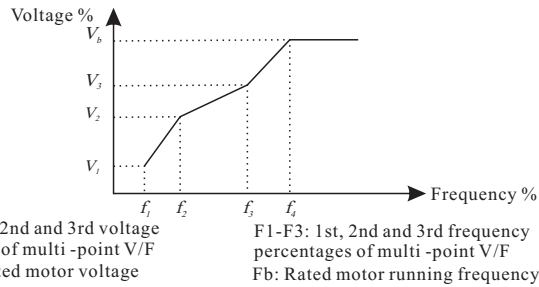

Figure 6-7 Setting of multi-point V/F curve

Function Code	Parameter Name	Setting Range	Default
F04.09	Motor1 V/F slip compensation gain	0.0%~200.0%	0.0%

This parameter is valid only for the asynchronous motor.

It can compensate the rotational speed slip of the asynchronous motor when the load of the motor increases, stabilizing the motor speed in case of load change. If this parameter is set to 100%, it indicates that the compensation when the motor bears rated load is the rated motor slip. The rated motor slip is automatically obtained by the AC drive through calculation based on the rated motor frequency and rated motor rotational speed in group F02.

Generally, if the motor rotational speed is different from the target speed, slightly adjust this parameter.

Function Code	Parameter Name	Setting Range	Default
F04.10	V/F over-excitation gain	0~200	64

During deceleration of the AC drive, over-excitation can restrain rise of the bus voltage, preventing the overvoltage fault. The larger the over-excitation is, the better the restraining result is.

Increase the over-excitation gain if the AC drive is liable to overvoltage error during deceleration. However, too large over-excitation gain may lead to an increase in the output current.

Set the over-excitation gain to 0 in the applications where the inertia is small and the bus voltage will not rise during motor deceleration or where there is a braking resistor.

Function Code	Parameter Name	Setting Range	Default
F04.11	V/F oscillation suppression gain	0~100	Model dependent

Set this parameter to a value as small as possible in the prerequisite of efficient oscillation suppression to avoid influence on V/F control.

Set this parameter to 0 if the motor has no oscillation. Increase the value properly only when the motor has obvious oscillation. The larger the value is, the better the oscillation suppression result will be.

When the oscillation suppression function is enabled, the rated motor current and no-load current must be correct. Otherwise, the V/F oscillation suppression effect will not be satisfactory.

Function Code	Parameter Name	Setting Range	Default
F04.13	Voltage source for V/F separation	0: digital setting (F04.14) 1: analog AI1 2: analog AI2 3: analog AI3 4: pulse (HDI) 5: multi-speed operation 6: simple PLC 7: PID control 8: RS485 Communication (corresponding F02.04 digital setting)	0
F04.14	Voltage digital setting for V/F separation	0V~F02.04(motor rated voltage)	0V

V/F separation is generally applicable to scenarios such as induction heating, inverse power supply and motor torque control.

If V/F separated control is enabled, the output voltage can be set in F04.14 or by means of analog, multi-reference, simple PLC, PID or communication. If you set the output voltage by means of non-digital setting, 100% of the setting corresponds to the rated motor voltage. If a negative percentage is set, its absolute value is used as the effective value.

• 0: Digital setting (F04.14)

The output voltage is set directly in F04.14.

• 1: AI1; 2: AI2; 3: AI3

The output voltage is set by AI terminals.

• 4: Pulse setting (HDI)

The output voltage is set by pulses of the terminal.

Pulse setting specification: voltage range 9–26V, frequency range 0–100 kHz

• 5: Multi-speed operation

If the voltage source is multi-speed command, parameters in group F05 and F12 must be set to determine the corresponding relationship between setting signal and setting voltage. 100.0% of the multi-speed setting in group F12 corresponds to the rated motor voltage.

• 6: Simple PLC

If the voltage source is simple PLC mode, parameters in group F12 must be set to determine the setting output voltage.

• 7: PID control

The output voltage is generated based on PID closed loop. For details, see the description of PID in group F10.

• 8: Rs485 communication

The output voltage is set by the host computer by means of communication.

The voltage source for V/F separation is set in the same way as the frequency source. 100.0% of the setting in each mode corresponds to the rated motor voltage.

If the corresponding value is negative, its absolute value is used.

Function Code	Parameter Name	Setting Range	Default
F04.15	Voltage rise time for V/F separation	0.0s ~ 1000.0s note: time from 0V to motor rated voltage (F02.04)	0.0s
F04.16	Voltage drop time for V/F separation	0.0s ~ 1000.0s Note: it refers to the time when 0V changes to rated voltage of motor	0.0s

V / F separation rise time refers to the time required for output voltage to change from 0V to rated voltage of motor. See T1 figure.

V / F separation falling time refers to the time required for output voltage to change from rated voltage of motor to 0V. See T2 figure.

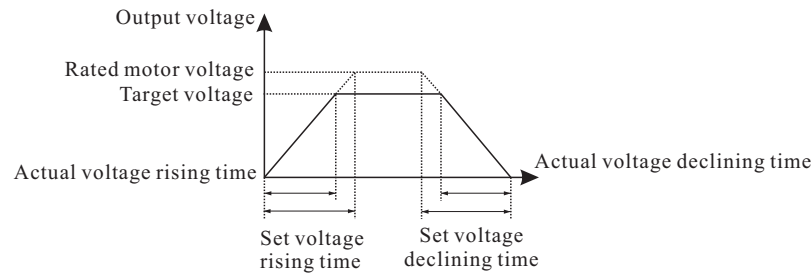

Figure 6-8 Voltage of V/F separation

Function Code	Parameter Name	Setting Range	Default
F04.17	Shut down mode for V/F separation	0: frequency / voltage reduced to 0 independently 1: voltage reduced to 0, the frequency reduced again	0

V / F separation output voltage decreases to 0V according to voltage drop time (F00.16);
V / F separation output frequency decreases to 0Hz according to deceleration time (F00.13).

Function Code	Parameter Name	Setting Range	Default
F04.18	Overcurrent stall action current	50 ~ 200%	150%
F04.19	Over current stall suppression enable	0: disabled 1: enabled	1
F04.20	Over current stall suppression gain	0 ~ 100	20
F04.21	Current compensation coefficient of double speed over-current stall action	50 ~ 200%	50%

In the high frequency region, the motor drive current is small, compared to the rated frequency, the speed of the same stall current drops greatly. In order to improve the operation characteristics of the motor, the stall action current above the rated frequency can be reduced. In some centrifuges with high operating frequency, several times of weak magnetic field and large load inertia, this method has a good effect on acceleration performance.

Group F05: Input terminals

The drive provides six multi-function digital input (DI) terminals and three analog input (AI) terminals. The optional extension card provides another four DI terminals (S7 to HDI), (HDI can be used for high-speed pulse input)

Function Code	Parameter Name	Setting Range	Default
F05.00	S1 terminal function	0~50	1
F05.01	S2 terminal function	0~50	2
F05.02	S3 terminal function	0~50	9
F05.03	S4 terminal function	0~50	12
F05.04	S5 terminal function	0~50	13
F05.05	S6 terminal function	0~50	4
F05.06	S7 terminal function	0~50	0
F05.07	S8 terminal function	0~50	0
F05.08	S9 terminal function	0~50	0
F05.09	HDI terminal function	0~50	0

The following table lists the functions available for the DI terminals.

Value	Function	Description
0	No function	Set 0 for reserved terminals to avoid malfunction.
1	Forward RUN (FWD)	The terminal is used to control forward or reverse RUN of the AC drive.
2	Reverse RUN (REV)	
3	3- wire operation control	The terminal determines three-line control of the AC drive. For details, see the description of F05.13.
4	Forward jog	Forward jog indicates forward JOG running, while reverse jog indicates reverse JOG running. The JOG frequency, acceleration time and deceleration time are described respectively in F08.06, F08.07 and F08.08.
5	Reverse jog	
6	Coast to stop	The AC drive blocks its output, the motor coasts to rest and is not controlled by the AC drive. It is the same as coast to stop described in F02.10.

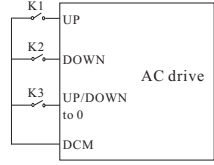
Value	Function	Description
7	Fault reset (RESET)	The terminal is used for fault reset function, the same as the function of RESET key on the operation panel. Remote fault reset is implemented by this function.
8	Normally open (NO) input of external fault	If this terminal becomes ON, the AC drive reports E00d and performs the fault protection action. For more details, see the description of F09.21.
9	Terminal UP	<p>If the frequency is determined by external terminals, the terminals with the two functions are used as increment and decrement commands for frequency modification.</p> 
10	Terminal DOWN	
11	Clear UP/ DOWN (terminal, keypad)	
12	Multi- speed terminal 1	The setting of 16 speed or 16 other commands can be implemented through combinations of 16 states of these four terminals.
13	Multi- speed terminal 2	
14	Multi- speed terminal 3	
15	Multi- speed terminal 4	
16	Pause operation	The AC drive decelerates to stop, but the running parameters are all memorized, such as PLC, swing frequency and PID parameters. After this function is disabled, the AC drive resumes its status before stop.
17	Acc/ Dec time selection 1	Totally four groups of acceleration/deceleration time can be selected through combinations of two states of these two terminals.
18	Acc/ Dec time selection 2	
19	Frequency source switch over	The terminal is used to perform switch over between two frequency sources according to the setting in F00.09.
20	Run command switch over terminal	If the command source is set to terminal control (F00.01= 1), this terminal is used to perform switch over between terminal control and keypad control. If the command source is set to communication control (F00.01 = 2), this terminal is used to perform switch over between communication control and keypad control.

Value	Function	Description
21	Acceleration/Deceleration prohibited	It enables the AC drive to maintain the current frequency output without being affected by external signals (except the STOP command).
22	PID pause	PID is invalid temporarily. The AC drive maintains the current frequency output without supporting PID adjustment of frequency source.
23	PLC status reset	The terminal is used to restore the original status of PLC control for the AC drive when PLC control is started again after a pause.
24	Swing pause	The AC drive outputs the central frequency, and the swing frequency function pauses.
25	Terminal count	Count once when terminal close once.
26	Counter reset	This terminal is used to clear the counter status.
27	Length count input	This terminal is used to count the length.
28	Length reset	This terminal is used to clear the length.
29	Torque control prohibited	The AC drive is prohibited from torque control and enters the speed control mode.
30	Pulse input (enabled only for HDI)	HDI is used for pulse input.
31	Reserved	reserved
32	Immediate DC braking	After this terminal becomes ON, the AC drive directly switches over to the DC braking state.
33	Normally closed (NC) input of external fault	After this terminal becomes ON, the AC drive reports E00d and stops.
34	Frequency modification forbidden	After this terminal becomes ON, the AC drive does not respond to any frequency modification.
35	Reverse PID action direction	After this terminal becomes ON, the PID action direction is reversed to the direction set in FA-03.
36	External STOP terminal 1	In operation panel mode, this terminal can be used to stop the AC drive, equivalent to the function of the STOP key on the operation panel.
37	Command source switch over terminal 2	It is used to perform switch over between terminal control and communication control. If the command source is terminal control, the system will switch over to communication control after this terminal becomes ON.
38	PID integral pause	After this terminal becomes ON, the integral adjustment function pauses. However, the proportional and differentiation adjustment functions are still valid.

Value	Function	Description
41	Motor selection terminal 1	Switch over among the two groups of motor parameters can be implemented through the two state combinations of these 2 two terminals.
43	PID parameter switch over	If the PID parameters switch over performed by means of DI terminal (F10.18 = 1), the PID parameters are F10.05 to F10.07 when the terminal becomes OFF; the PID parameters are F10.15 to F10.17 when this terminal becomes ON.
46	Speed control/Torque control switch over	This terminal enables the AC drive to switch over between speed control and torque control. When this terminal becomes OFF, the AC drive runs in the mode set in A03.23. When this terminal becomes ON, the AC drive switches over to the other control mode.
47	Emergency stop	When this terminal becomes ON, the AC drive stops within the shortest time. During the stop process, the current remains at the set current upper limit. This function is used to satisfy the requirement of stopping the AC drive in emergency state.
48	External STOP terminal 2	In any control mode (operation panel, terminal or communication), it can be used to make the AC drive decelerate to stop. In this case, the deceleration time is deceleration time 4.
49	Deceleration DC braking	When this terminal becomes ON, the AC drive decelerates to the initial frequency of stop DC braking and then switches over to DC braking state.
50	Clear the current running time	When this terminal becomes ON, the AC drive's current running time is cleared. This function must be supported by F08.43 and F08.54.

The four multi-command terminals have 16 state combinations, corresponding to 16 reference values, as listed in the following table.

S1	S2	S3	S4	Multi-step speed setting	Corresponding Parameter
OFF	OFF	OFF	OFF	Multi-step speed 0	F12.02
ON	OFF	OFF	OFF	Multi-step speed 1	F12.03
OFF	ON	OFF	OFF	Multi-step speed 2	F12.04
ON	ON	OFF	OFF	Multi-step speed 3	F12.05
OFF	OFF	ON	OFF	Multi-step speed 4	F12.06
ON	OFF	ON	OFF	Multi-step speed 5	F12.07
OFF	ON	ON	OFF	Multi-step speed 6	F12.08
ON	ON	ON	OFF	Multi-step speed 7	F12.09
OFF	OFF	OFF	ON	Multi-step speed 8	F12.10
ON	OFF	OFF	ON	Multi-step speed 9	F12.11
OFF	ON	OFF	ON	Multi-step speed 10	F12.12
ON	ON	OFF	ON	Multi-step speed 11	F12.13
OFF	OFF	ON	ON	Multi-step speed 12	F12.14
ON	OFF	ON	ON	Multi-step speed 13	F12.15
OFF	ON	ON	ON	Multi-step speed 14	F12.16
ON	ON	ON	ON	Multi-step speed 15	F12.17

If the frequency source is multi-reference, the value 100% of F12.02 to F12.17 corresponds to the value of F00.03 (Maximum frequency).

Besides the multi-speed function, the multi-reference can be also used as the PID setting source or the voltage source for V/F separation, satisfying the requirement on switch over of different setting values.

Two terminals for acceleration/deceleration time selection have four state combinations, as listed in the following table.
State combinations of two terminals for acceleration/deceleration time selection as follow table:

Terminal 2	Terminal 1	Acceleration Time selection	Corresponding Parameters
OFF	OFF	Acceleration time 1	F00.12、 F00.13
OFF	ON	Acceleration time 1	F08.00、 F08.01
ON	OFF	Acceleration time 1	F08.02、 F08.03
ON	ON	Acceleration time 1	F08.04、 F08.05

State combinations of motor selection terminals as follow table:

Terminal	Selected Motor	Corresponding Parameters
OFF	Motor 1	Group F02
ON	Motor 2	Group F15

Function Code	Parameter Name	Setting Range	Default
F05.10	Input terminal valid mode selection 1	0: valid on high level 1: valid on low level units' digit: S1 tens' digit: S2 hundreds' digit: S3 thousands' digit: S4 ten thousands' digit: S5	00000
F05.11	Input terminal polarity selection 2	0: valid on high level 1: valid on low level units' digit: S6 tens' digit: S7 hundreds' digit: S8 thousands' digit: S9 ten thousands' digit: HDI	00000

These parameters are used to set the valid mode of digital input DI terminals.

• 0: High level valid

The DI terminal (S) is valid when being connected with COM, and invalid when being disconnected from COM.

• 1: Low level valid

The DI terminal (S) is invalid when being connected with COM, and invalid when being disconnected from COM.

Function Code	Parameter Name	Setting Range	Default
F05.12	Filtering time of switch	0.000s~1.000s	0.010s

It is used to set the software filter time of digital input (DI) terminal status. If DI terminals are liable to interference and may cause malfunction, increase the value of this parameter to enhance the anti-interference capability. However, increase of DI filter time will reduce the response of DI terminals.

Function Code	Parameter Name	Setting Range	Default
F05.13	Terminal control operation mode	0: 2- wire control 1 1: 2- wire control 2 2: 3- wire control 1 3: 3- wire control 2	0

This parameter is used to set the mode in which the AC drive is controlled by external terminals.

• 0: 2-wire mode 1

It is the most commonly used two-line mode, in which the forward/reverse rotation of the motor is decided by K1 and K2.

• 1: 2- wire control 2

In this mode, K1 is RUN enabled terminal, and K2 determines the running direction.

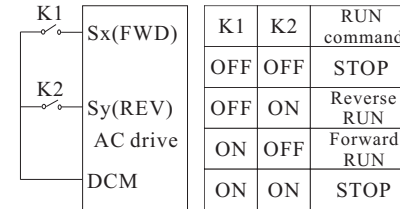

Figure 6-9 Setting of 2-wire control 1

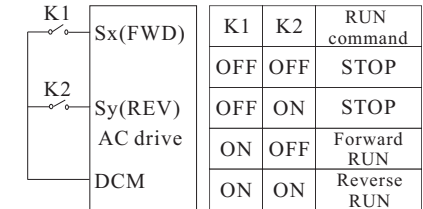

Figure 6-10 Setting of 2-wire control 2

When S1/S2 terminal is valid, if ac drive is stop by others stop command, it will not run even S1/S2 is valid. If you need run, it should press S1/S2 again.

• 2: 3-wire control 1

In this mode, EN is RUN enabled terminal, and the direction is decided by SW1 and SW3. STOP command is by normal close SW2

• 3: 3-wire control 2

In this mode, EN is RUN enabled terminal. The RUN command is given by SW1 and the direction is decided by K, EN is normal close input.

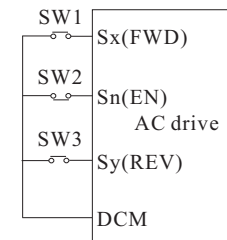

Figure 6-11 Setting of 3-wire control 1

SW1: forward run

SW2: stop run

SW3: reverse run

EN is 3-wire run enabled terminal

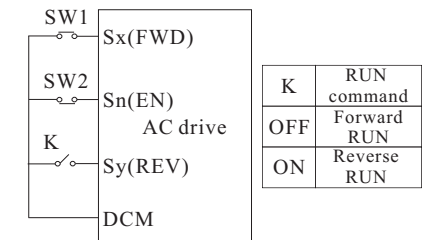

Figure 6-12 Setting of 3-wire control 2

K: forward/reverse

SW1: run

SW2: stop

EN is 3-wire run enabled terminal

Function Code	Parameter Name	Setting Range	Default
F05.14	Terminal UP/DOWN rate	0.001Hz/s~65.535Hz/s	1.00Hz/s

It is used to adjust the rate of change of frequency when the frequency is adjusted by means of terminal UP/DOWN.

• If F00.11 (Frequency reference resolution) is 2, the setting range is 0.001–65.535 Hz/s.

• If F00.11 (Frequency reference resolution) is 1, the setting range is 0.01–65.35 Hz/s.

Function Code	Parameter Name	Setting Range	Default
F05.15	S1 delay time	0.0s~3600.0s	0.0s
F05.16	S2 delay time	0.0s~3600.0s	0.0s
F05.17	S3 delay time	0.0s~3600.0s	0.0s

These parameters are used to set the delay time of the AC drive when the status of S terminals changes. Currently, only S1, S2 and S3 support the delay time function.

Function Code	Parameter Name	Setting Range	Default
F05.18	A11 lower limit	0.00V~F05.20	0.00V
F05.19	Corresponding setting of A11 lower limit	-100.0%~+100.0%	0.0%
F05.20	A11 upper limit	F05.18~+10.00V	10.00V
F05.21	Corresponding setting of A11 upper limit	-100.0%~+100.0%	100.0%
F05.22	A11 input filter time	0.00s~10.00s	0.10s

These parameters are used to define the relationship between the analog input voltage and the corresponding setting. When the analog input voltage exceeds the maximum value (F05.20), the maximum value is used. When the analog input voltage is less than the minimum value (F05.18), the value set in F05.19 (Setting for AI less than minimum input) is used.

When the analog input is current input, 1 mA current corresponds to 0.5 V voltage. F05.22 (AI1 filter time) is used to set the software filter time of AI1. If the analog input is liable to interference, increase the value of this parameter to stabilize the detected analog input. However, increase of the AI filter time will slow the response of analog detection. Set this parameter properly based on actual conditions.

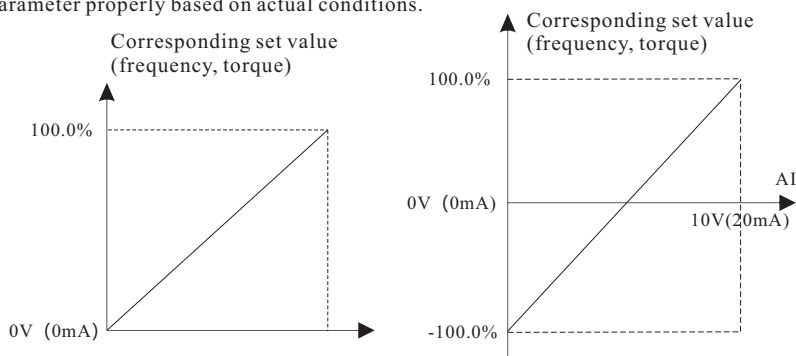

Figure 6-13 Corresponding relationship between analog input and set values

Function Code	Parameter Name	Setting Range	Default
F05.23	AI2 low limit	0.00V~F05.25	0.00V
F05.24	Corresponding setting of AI2 lower limit setting	-100.0%~+100.0%	0.0%
F05.25	AI2 upper limit	F05.23~+10.00V	10.00V
F05.26	Corresponding setting of AI2 upper limit	-100.0%~+100.0%	100.0%
F05.27	AI2 input filter time	0.00s~10.00s	0.10s

The method of setting AI2 functions is similar to that of setting AI1 function.

Function Code	Parameter Name	Setting Range	Default
F05.28	AI3 lower limit	-10.00V~F05.30	0V
F05.29	Corresponding setting of AI3 lower limit	-100.0%~+100.0%	0.0%
F05.30	AI3 upper limit	F05.28~+10.00V	4.00V
F05.31	Corresponding setting of AI3 upper limit	-100.0%~+100.0%	100.0%
F05.32	AI3 filter time	0.00s~10.00s	0.10s

The method of setting AI3 functions is similar to that of setting AI1 function.

Function Code	Parameter Name	Setting Range	Default
F05.33	HDI lower limit	0.00kHz~F05.35	0.00kHz
F05.34	Corresponding setting of HDI lower limit	-100.0%~+100.0%	0.0%
F05.35	HDI upper limit	F05.33~+100.00kHz	50.00kHz
F05.36	Corresponding setting of HDI upper limit	-100.0%~+100.0%	100.0%
F05.37	HDI frequency input filter time	0.00s~10.00s	0.10s

These parameters are used to set the relationship between HDI pulse input and corresponding settings. The pulses can only be input by HDI. The method of setting this function is similar to that of setting AI1 function.

Function Code	Parameter Name	Setting Range	Default
F05.38	AI curve selection	units' digit: AI curve selection 1: curve 1 (2 point, see F05.18 ~ F05.21) 2: curve 2 (2 point, see F05.23 ~ F05.26) 3: curve 3 (2 point, see F05.28 ~ F05.31) 4: curve 4 (4 point, see F05.40 ~ F05.47) 5: curve 5 (4 point, see F05.48 ~ F05.55) tens' digit: AI2 curve selection hundreds' digit: AI3 curve selection	H.321

The unit's digit, ten's digit and hundred's digit of this parameter are respectively used to select the corresponding curve of AI1, AI2 and AI3. Any of the five curves can be selected for AI1, AI2 and AI3.

Curve 1, curve 2 and curve 3 are all 2-point curves, set in group F4. Curve 4 and curve 5 are both 4-point curves.

Function Code	Parameter Name	Setting Range	Default
F05.39	Setting for AI less than minimum input	units' digit: (setting for AI1 less than minimum input) 0: corresponding to the minimum input set 1: 0.0% tens' digit: (setting for AI2 less than minimum input) setting selection hundreds' digit: (setting for AI3 less than minimum input)	H.000

This parameter is used to determine the corresponding setting when the analog input voltage is less than the minimum value. The unit's digit, ten's digit and hundred's digit of this parameter respectively correspond to the setting for AI1, AI2 and AI3.

If the value of a certain digit is 0, when analog input voltage is less than the minimum input, the corresponding setting of the minimum input (F05.19, F05.24, F05.29) is used. If the value of a certain digit is 1, when analog input voltage is less than the minimum input, the corresponding value of this analog input is 0.0%.

Function Code	Parameter Name	Setting Range	Default
F05.40	AI curve 4 lower limit	-10.00V~F05.42	0.00V
F05.41	Corresponding setting of AI curve 4 lower limit	-100.0%~+100.0%	0.0%
F05.42	AI curve 4 inflection point 1 input	F05.40~F05.44	3.00V
F05.43	Corresponding setting of AI curve 4 inflection point 1 input	-100.0%~+100.0%	30.0%
F05.44	AI curve 4 inflection point 2 input	F05.42~F05.46	6.00V
F05.45	Corresponding setting of AI curve 4 inflection point 2 input	-100.0%~+100.0%	60.0%
F05.46	AI curve 4 upper limit	F05.44~+10.00V	10.00V
F05.47	AI curve 4 upper limit	-100.0%~+100.0%	100.0%
F05.48	AI curve 5 lower limit	-10.00V~F05.50	-10.00V
F05.49	Corresponding setting of AI curve 5 lower limit	-100.0%~+100.0%	-100.0%
F05.50	AI curve 5 inflection point 1 input	F05.48~F05.52	-3.00V
F05.51	Corresponding setting of AI curve 5 inflection point 1 input	-100.0%~+100.0%	-30.0%
F05.52	AI curve 5 inflection point 2 input	F05.50~F05.54	3.00V
F05.53	Corresponding setting of AI curve 5 inflection point 2 input	-100.0%~+100.0%	30.0%

Function Code	Parameter Name	Setting Range	Default
F05.54	AI curve 5 upper limit	F05.52~+10.00V	10.00V
F05.55	Corresponding setting of AI curve 5 upper limit	-100.0%~+100.0%	100.0%

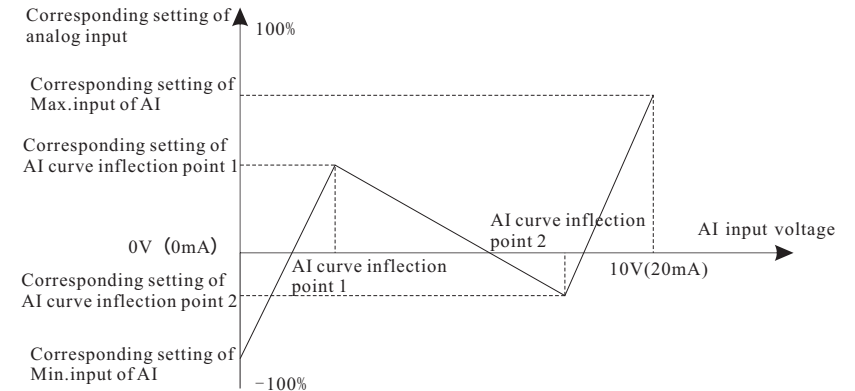

Figure 6-14 Curve 4 and curve 5

Function Code	Parameter Name	Setting Range	Default
F05.64	AI1 jump point setting	-100.0%~100.0%	0.0%
F05.65	AI1 jump point range setting	0.0%~100.0%	0.5%
F05.66	AI2 jump point setting	-100.0%~100.0%	0.0%
F05.67	AI2 jump point range setting	0.0%~100.0%	0.5%
F05.68	AI3 jump point setting	-100.0%~100.0%	0.0%
F05.69	AI3 jump point range setting	0.0%~100.0%	0.5%

The analog input AI1 ~ AI3 of AC has set value jump function. Jump function means that when the corresponding setting of analog quantity changes in the upper and lower range of the jump point, the corresponding set value of analog quantity is fixed as the value of the jump point

For example: the voltage of analog input AI1 fluctuates around 5.00V. The fluctuation range is 4.90V ~ 5.10V. When the minimum input of AI1 is 0.00v and the maximum input is 10.00V, the corresponding setting of AI1 is between 49.0% and 510%. Set AI1 to set the jump point F05.64 to 50.0%, set AI1 to set the jump amplitude F05.65 to 1.0%. When the AI1 input is above, after the jump function processing, the corresponding setting of AI1 input is fixed at 50.0%, and AI1 is transformed into a stable input to eliminate the fluctuation.

Group F06: Output Terminals

The drive provides 2 analog output (AO) terminal, 1 open-collector switch signal output, 2 relay terminal and a HDO terminal (used for high-speed pulse output or open-collector switch signal output) as standard. If these output terminals cannot satisfy requirements, use an optional I/O extension card that provides an AO terminal (AO2), a relay terminal (relay 2) and a DO terminal (DO2).

Function Code	Parameter Name	Setting Range	Default
F06.00	HDO terminal output mode	0: Pulse output (HDOP) 1: Switch signal output (HDOR)	0
F06.01	HDOR output selection	0~40	0
F06.02	Relay TA output selection (TA*TB*TC)		2
F06.03	Relay RA output selection (RA*RB*RC)		0
F06.04	MO1 output selection		1

These five parameters are used to select the functions of the five digital output terminals. TA*TB*TC and RA*RB*RC are respectively the relays on the control board. The functions of the output terminals are described in the following table.

Value	Function	Description
0	no output	The terminal has no function.
1	frequency reached	Refer to the descriptions of F08.24.
2	frequency-level detection FDT1 output	Refer to the descriptions of F08.20 and F08.21
3	fault output (stop)	When the AC drive stops due to a fault, the terminal becomes ON.
4	motor overload pre-warning	The AC drive judges whether the motor load exceeds the overload pre-warning threshold before performing the protection action. If the pre-warning threshold is exceeded, the terminal becomes ON. For motor overload parameters, see the descriptions of F09.09 to F09.11.
5	AC drive overload pre-warning	The terminal becomes ON 10s before the AC drive overload protection action is performed.
6	zero-speed running (no output at stop)	If the AC drive runs with the output frequency of 0, the terminal becomes ON. If the AC drive is in the stop state, the terminal becomes OFF.
7	zero-speed running 2 (no output at stop)	If the output frequency of the AC drive is 0, the terminal becomes ON. In the state of stop, the signal is still ON.

Value	Function	Description
8	frequency upper limit reached	If the running frequency reaches the upper limit, the terminal becomes ON.
9	frequency lower limit reached (no output at stop)	If the running frequency reaches the lower limit, the terminal becomes ON. In the stop state, the terminal becomes OFF.
10	set count value reached	The terminal becomes ON when the count value reaches the value set in F11.08.
11	designated count value reached	The terminal becomes ON when the count value reaches the value set in F11.09.
12	length reached	The terminal becomes ON when the detected actual length exceeds the value set in F11.05.
13	PLC cycle complete	When simple PLC completes one cycle, the terminal outputs a pulse signal with width of 250 ms.
14	accumulative running time reached	If the accumulative running time of the AC drive exceeds the time set in F08.16, the terminal becomes ON.
15	frequency limited	If the set frequency exceeds the frequency upper limit or lower limit and the output frequency of the AC drive reaches the upper limit or lower limit, the terminal becomes ON.
16	torque limited	In speed control mode, if the output torque reaches the torque limit, the AC drive enters the stall protection state and meanwhile the terminal becomes ON.
17	ready for RUN	If the AC drive main circuit and control circuit become stable, and the AC drive detects no fault and is ready for RUN, the terminal becomes ON.
18	AC drive running	When the AC drive is running and has output frequency (can be zero), the terminal becomes ON.
19	AI1 > AI2	When the input of AI1 is larger than the input of AI2, the terminal becomes ON.
20	undervoltage state output	If the AC drive is in undervoltage state, the terminal becomes ON.
22	reserved	reserved
23	reserved	reserved

Value	Function	Description
24	accumulative power-on time reached	If the AC drive accumulative power-on time (F07.13) exceeds the value set in F08.15, the terminal becomes ON.
25	frequency level detection FDT2 output	Refer to the descriptions of F08.22 and F08.23.
26	frequency 1 reached	Refer to the descriptions of F08.31 and F08.32.
27	frequency 2 reached	Refer to the descriptions of F08.33 and F08.34.
28	current 1 reached	Refer to the descriptions of F08.39 and F08.40.
29	current 2 reached	Refer to the descriptions of F08.41 and F08.42.
30	timing reached	If the timing function (F08.43) is valid, the terminal becomes ON after the current running time of the AC drive reaches the set time.
31	A11 input limit exceeded	If A11 input is larger than the value of F08.47 (A11 input voltage upper limit) or lower than the value of F08.46 (A11 input voltage lower limit), the terminal becomes ON.
32	load becoming 0	If the load becomes 0, the terminal becomes ON.
33	reverse running	If the AC drive is in the reverse running state, the terminal becomes ON.
34	zero current state	Refer to the descriptions of F08.22 and F08.23.
35	module temperature reached	If the heatsink temperature of the inverter module (F07.08) reaches the set module temperature threshold (F08.48), the terminal becomes ON.
36	output current limit exceeded	Refer to the descriptions of F08.37 and F08.38.
37	frequency lower limit reached (having output at stop)	If the running frequency reaches the lower limit, the terminal becomes ON. In the stop state, the signal is still ON.
38	alarm output (keep running)	If a fault occurs on the AC drive and the AC drive continues to run, the terminal outputs the alarm signal.
39	motor overheat warning	If the motor temperature reaches the temperature set in F09.59 (motor overheat warning threshold), the terminal becomes ON.
40	current running time reached	If the current running time of AC drive exceeds the value of F08.54, the terminal becomes ON.

Function Code	Parameter Name	Setting Range	Default
F06.06	Output terminal valid mode selection	0: Positive logic 1: Negative logic Unit's digit: HDO Ten's digit: TA Hundred's digit: RA Thousand's digit: MO1	0.0s

It is used to set the logic of output terminals HDO, relay 1, relay 2, MO1.

• 0: Positive logic

The output terminal is valid when being connected with COM, and invalid when being disconnected from COM.

• 1: Positive logic

The output terminal is invalid when being connected with COM, and valid when being disconnected from COM.

Function Code	Parameter Name	Setting Range	Default
F06.07	HDO delay time	0.0s~3600.0s	0.0s
F06.08	TA delay time	0.0s~3600.0s	0.0s
F06.09	RA delay time	0.0s~3600.0s	0.0s
F06.10	MO1 output delay time	0.0s~3600.0s	0.0s

These parameters are used to set the delay time of output terminals HDO, relay 1, relay 2, MO1 from status change to actual output.

Function Code	Parameter Name	Setting Range	Default
F06.12	HDOP output selection	0~15	0
F06.13	AO1 output selection		0
F06.14	AO2 output selection		1

The output pulse frequency of the HDOP terminal ranges from 0.01 kHz to "HDO output max.frequency" (F06.22). The value of F06.22 is between 0.01 kHz and 100.00 kHz.

The output range of AO1 and AO2 is 0–10 V or 0–20 mA. The relationship between pulse and analog output ranges and corresponding functions is listed in the following table:

Value	Function	Description
0	setting frequency	0 to maximum output frequency
1	running frequency	0 to maximum output frequency
2	output current	0 to 2 times of rated motor current
3	output voltage	0 to 1.2 times of rated AC drive voltage
4	output speed	0 to rotational speed corresponding to maximum output frequency
5	output torque	0 to 2 times of rated motor torque
6	output power	0 to 2 times of rated power
7	pulse input	0.01kHz~100.00kHz
8	AI1	0V~10V
9	AI2	0V~10V (or 0~20mA)
10	AI3	0V~10V
11	length	0 to maximum set length
12	count value	0 to maximum count value
13	Rs485 communication	0.0%~100.0%
14	output current 100% corresponding to 1000.0A	0.0A~1000.0A
15	output voltage 100% corresponding to 1000.0V	0.0V~1000.0V

Function Code	Parameter Name	Setting Range	Default
F06.15	AO1 offset coefficient	-100.0%~100.0%	0.0%
F06.16	AO1 gain	-10.00~+10.00	1.00
F06.17	AO1 offset coefficient	-100.0%~100.0%	0.0%
F06.18	AO1 gain	-10.00~+10.00	1.00

These parameters are used to correct the zero drift of analog output and the output amplitude deviation. They can also be used to define the desired AO curve.

If "b" represents zero offset, "k" represents gain, "Y" represents actual output, and "X" represents standard output, the actual output is: $Y = kX + b$.

The zero offset coefficient 100% of AO1 and AO2 corresponds to 10 V (or 20 mA). The standard output refers to the value corresponding to the analog output of 0 to 10 V (or 0 to 20 mA) with no zero offset or gain adjustment.

For example, if the analog output is used as the running frequency, and it is expected that the output is 8 V when the frequency is 0 and 3 V at the maximum frequency, the gain shall be set to -0.50, and the zero offset shall be set to 80%.

Function Code	Parameter Name	Setting Range	Default
F06.19	AO1 output filter time	0~10.00	0
F06.20	AO2 output filter time	0~10.00	0
F06.21	HDO output filter time	0~10.00	0

Function Code	Parameter Name	Setting Range	Default
F06.22	HDO output max.frequency	0.01kHz~100.00kHz	50.00kHz

This function code is used to select max.frequency of output pulse when HDO terminal as pulse output.

Group F07: Keypad And Display

Function Code	Parameter Name	Setting Range	Default
F07.00	User password	0~65535	0

Press FUNC/DATA key to confirm password.
Don't press again within 1 minute, password will saved.

If no need password, setting to 00000.

Function Code	Parameter Name	Setting Range	Default
F07.02	STOP key function selection	0: STOP/RST key enabled only in keypad control 1: STOP/RST key enabled in any operation mode	1
F07.03	LED display running parameters 1	0000~FFFF	H.008F

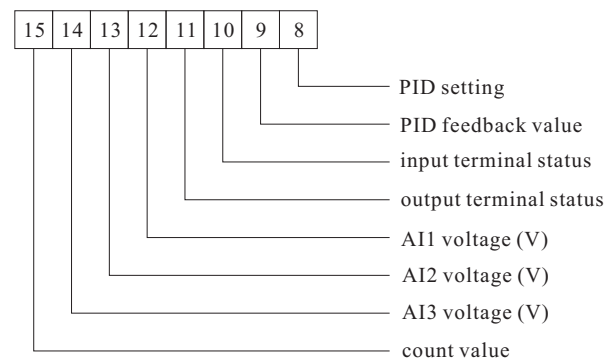
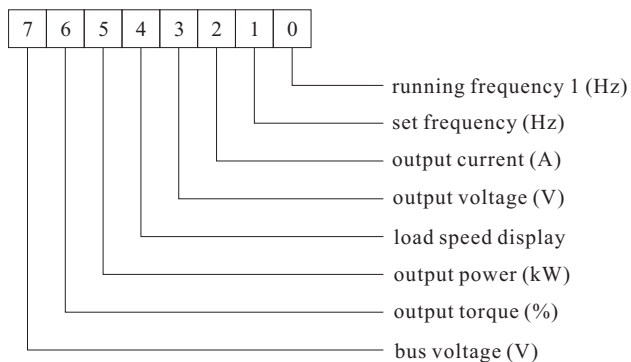

If a parameter needs to be displayed during the running, set the corresponding bit to 1, and set F07.03 to the hexadecimal equivalent of this binary number.

Function Code	Parameter Name	Setting Range	Default
F07.04	LED display running parameters 2	0000~FFFF	H.0000

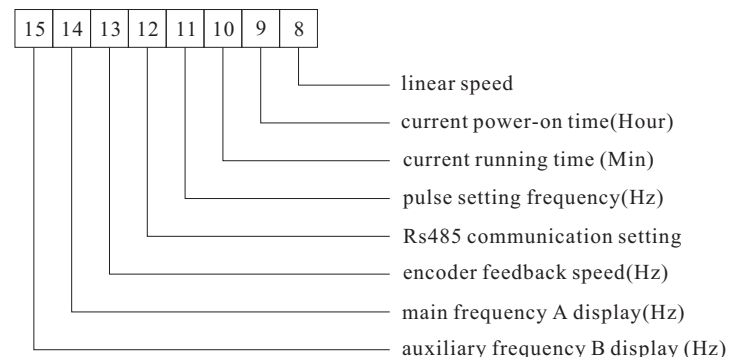
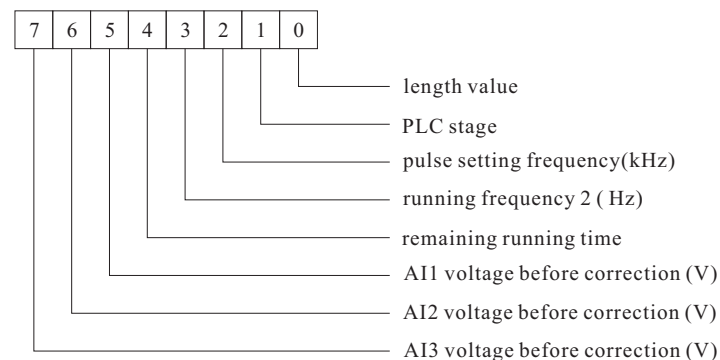

If a parameter needs to be displayed during the running, set the corresponding bit to 1, and set F07.04 to the hexadecimal equivalent of this binary number.

These two parameters are used to set the parameters that can be viewed when the AC drive is in the running state. You can view a maximum of 32 running state parameters that are displayed from the lowest bit of F07.03.

Function Code	Parameter Name	Setting Range	Default
F07.05	LED display stop parameters	0000~FFFF	H.0063

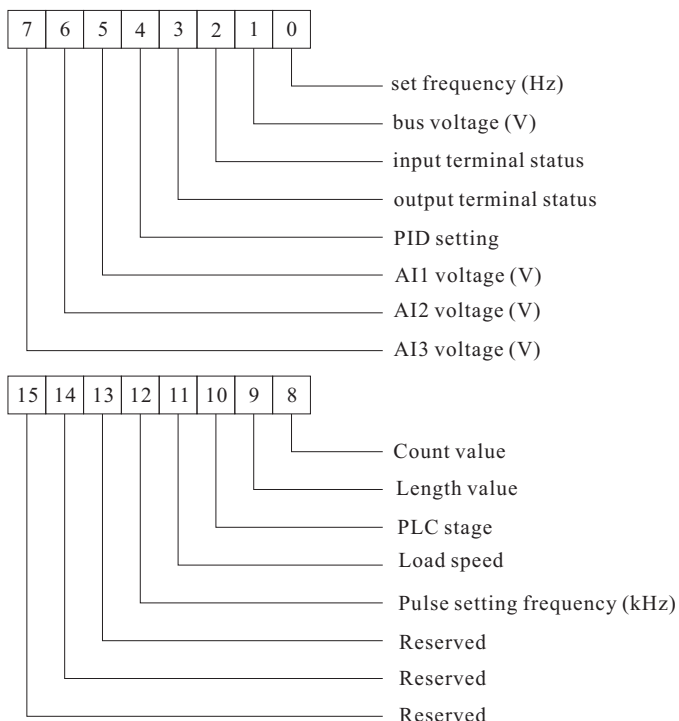

If a parameter needs to be displayed during the running, set the corresponding bit to 1, and set F07.05 to the hexadecimal equivalent of this binary number.

Function Code	Parameter Name	Setting Range	Default
F07.06	Load speed display coefficient	0.0001~6.5000	1.0000

This parameter is used to adjust the relationship between the output frequency of the AC drive and the load speed. For details, see the description of F07.12.

Function Code	Parameter Name	Setting Range	Default
F07.07	Heatsink temperature of rectifier bridge	0.0°C ~100.0°C	-

Function Code	Parameter Name	Setting Range	Default
F07.08	Heatsink temperature of inverter module	0.0°C ~100.0°C	-
F07.09	Software version	-	-
F07.10	Accumulative running time	0h~65535h	-
F07.11	Product number	-	-

These function code can not be modify.

Heatsink temperature of inverter module is used to display the insulated gate bipolar transistor (IGBT) temperature of the inverter module, and the IGBT overheat protection value of the inverter module depends on the model.

Function Code	Parameter Name	Setting Range	Default
F07.12	Number of decimal places for load speed display	0: 0 decimal place 1: 1 decimal place 2: 2 decimal places 3: 3 decimal places	1

F07.12 is used to set the number of decimal places for load speed display. The following gives an example to explain how to calculate the load speed:

Assume that F07.06 (Load speed display coefficient) is 2.000 and F07.12 is 2 (2 decimal places). When the running frequency of the AC drive is 40.00 Hz, the load speed is $40.00 \times 2.000 = 80.00$ (display of 2 decimal places).

If the AC drive is in the stop state, the load speed is the speed corresponding to the set frequency, namely, "set load speed". If the set frequency is 50.00 Hz, the load speed in the stop state is $50.00 \times 2.000 = 100.00$ (display of 2 decimal places).

Function Code	Parameter Name	Setting Range	Default
F07.13	Accumulative power-on time	0h~65535h	-

It is used to display the accumulative power-on time of the AC drive since the delivery. If the time reaches the set power-on time (F08.16), the terminal with the digital output function 24 becomes ON.

Function Code	Parameter Name	Setting Range	Default
F07.14	Accumulative power consumption	0~65535 kWh	-

It is used to display the accumulative power consumption of the AC drive until now.

Group F08: Auxiliary Functions

Function Code	Parameter Name	Setting Range	Default
F08.00	Acceleration time 2	0.0s~6500.0s	Model dependent
F08.01	Deceleration time 2	0.0s~6500.0s	Model dependent
F08.02	Acceleration time 3	0.0s~6500.0s	Model dependent
F08.03	Deceleration time 2	0.0s~6500.0s	Model dependent
F08.04	Acceleration time 4	0.0s~6500.0s	Model dependent
F08.05	Deceleration time 2	0.0s~6500.0s	Model dependent

The drive provides a total of four groups of acceleration/deceleration time, that is, the preceding three groups and the group defined by F00.12 and F00.13. Definitions of four groups are completely the same. You can switch over between the four groups of acceleration/deceleration time through different state combinations of digital input(S) terminals. For more details, see the descriptions of F05.01 to F05.05.

Function Code	Parameter Name	Setting Range	Default
F08.06	JOG running frequency	0.00Hz ~ F00.03(max. frequency)	2.00Hz
F08.07	JOG acceleration time	0.0s~6500.0s	20.0s
F08.08	JOG deceleration time	0.0s~6500.0s	20.0s

These parameters are used to define the set frequency and acceleration/deceleration time of the AC drive when jogging. The startup mode is "Direct start" (F01.00 = 0) and the stop mode is "Decelerate to stop" (F01.08 = 0) during jogging.

Function Code	Parameter Name	Setting Range	Default
F08.09	Jump frequency 1	0.00Hz ~ F00.03(max. frequency)	0.00Hz
F08.10	Jump frequency 2	0.00Hz ~ F00.03(max. frequency)	0.00Hz
F08.11	Frequency jump amplitude	0.00Hz ~ F00.03(max. frequency)	0.00Hz

If the set frequency is within the frequency jump range, the actual running frequency is the jump frequency close to the set frequency. Setting the jump frequency helps to avoid the mechanical resonance point of the load.

The drive supports two jump frequencies. If both are set to 0, the frequency jump function is disabled. The principle of the jump frequencies and jump amplitude is shown in the following figure 6-15.

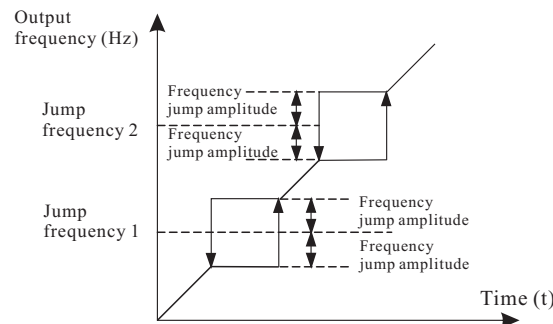

Figure 6-15 Principle of the jump frequencies and jump amplitude

Function Code	Parameter Name	Setting Range	Default
F08.12	Forward/Reverse rotation dead-zone time	0.0s~3000.0s	0.0s

It is used to set the time when the output is 0 Hz at transition of the AC drive forward rotation and reverse rotation, as shown in the following figure.

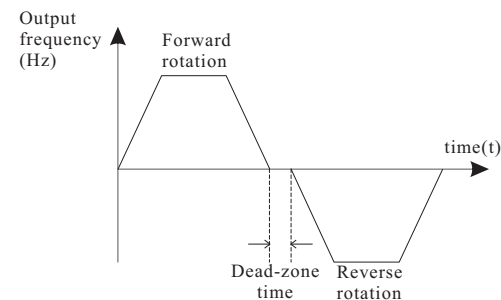

Figure 6-16 Forward/Reverse rotation dead-zone time

Function Code	Parameter Name	Setting Range	Default
F08.13	Reverse control	0: enabled 1: disabled	0

It is used to set whether the AC drive allows reverse rotation. In the applications where reverse rotation is prohibited, set this parameter to 1.

Function Code	Parameter Name	Setting Range	Default
F08.14	Running mode when set frequency lower than frequency lower limit	0: run at frequency lower limit 1: stop 2: run at zero speed	0

It is used to set the AC drive running mode when the set frequency is lower than the frequency lower limit. The AC provides three running modes to satisfy requirements of various applications.

Function Code	Parameter Name	Setting Range	Default
F08.15	Accumulative power-on time threshold	0h~65000h	0h

If the accumulative power-on time (F07.13) reaches the value set in this parameter, the corresponding DO terminal becomes ON.

Function Code	Parameter Name	Setting Range	Default
F08.16	Accumulative running time threshold	0h~65000h	0h

It is used to set the accumulative running time threshold of the AC drive. If the accumulative running time (F07.10) reaches the value set in this parameter, the corresponding DO terminal becomes ON.

Function Code	Parameter Name	Setting Range	Default
F08.17	Startup protection	0: No 1: Yes	0

This parameter is used to set whether to enable the safety protection. If it is set to 1, the AC drive does not respond to the run command valid upon AC drive power-on (for example, an input terminal is ON before power-on). The AC drive responds only after the run command is cancelled and becomes valid again.

In addition, the AC drive does not respond to the run command valid upon fault reset of the AC drive. The run protection can be disabled only after the run command is cancelled. In this way, the motor can be protected from responding to run commands upon power-on or fault reset in unexpected conditions.

Function Code	Parameter Name	Setting Range	Default
F08.18	Droop control	0.00Hz~10.00Hz	0.00Hz

This function is used for balancing the workload allocation when multiple motors are used to drive the same load. The output frequency of the AC drives decreases as the load increases. You can reduce the workload of the motor under load by decreasing the output frequency for this motor, implementing workload balancing between multiple motors.

Function Code	Parameter Name	Setting Range	Default
F08.19	Motor switch over	0:Motor 1 1:Motor 2	0

Function Code	Parameter Name	Setting Range	Default
F08.20	Frequency detection value (FDT1)	0.00Hz~F00.03(max.frequency)	50.00Hz
F08.21	Frequency detection hysteresis (FDT hysteresis 1)	0.0%~100.0% (FDT1 level)	5.0%
F08.22	Frequency detection value (FDT2)	0.00Hz~F00.03(max.frequency)	50.00Hz
F08.23	Frequency detection hysteresis (FDT hysteresis 2)	0.0%~100.0% (FDT2 level)	5.0%

If the running frequency is higher than the value of F08.20, the corresponding multi-function output terminal becomes ON. If the running frequency is lower than value of F08.20, multi-function output terminal goes OFF.

These two parameters are respectively used to set the detection value of output frequency and hysteresis value upon cancellation of the output. The value of F08.21 is a percentage of the hysteresis frequency to the frequency detection value (F08.20).

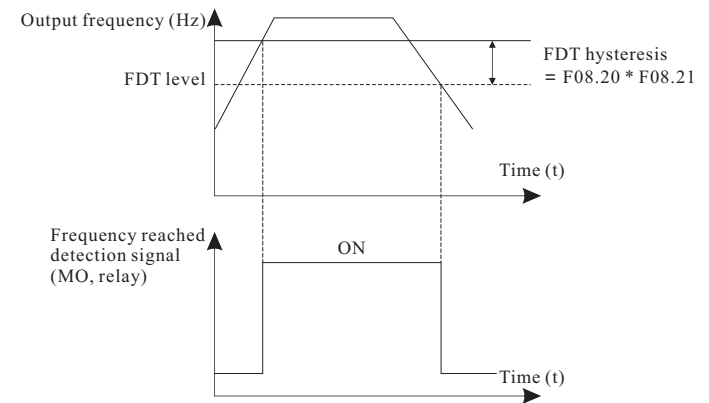

Figure 6-17 The FDT function

Function Code	Parameter Name	Setting Range	Default
F08.24	Detection range of frequency reached	0.0%~100.0% (max.frequency)	0.0%

If the AC drive running frequency is within the certain range of the set frequency, the corresponding multi-function output terminal becomes ON.

This parameter is used to set the range within which the output frequency is detected to reach the set frequency. The value of this parameter is a percentage relative to the maximum frequency. The detection range of frequency reached is shown in the following figure.

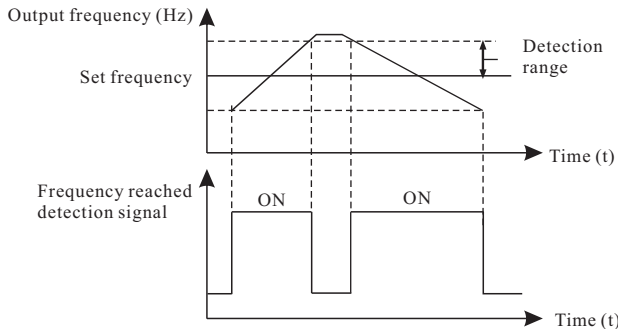

Figure 6-18 Detection range of frequency reached

Function Code	Parameter Name	Setting Range	Default
F08.25	Jump frequency during acceleration/deceleration	0: disabled 1: enabled	0

It is used to set whether the jump frequencies are valid during acceleration/deceleration.

When the jump frequencies are valid during acceleration/deceleration, and the running frequency is within the frequency jump range, the actual running frequency will jump over the set frequency jump amplitude (rise directly from the lowest jump frequency to the highest jump frequency). The following figure shows the diagram when the jump frequencies are valid during acceleration/deceleration.

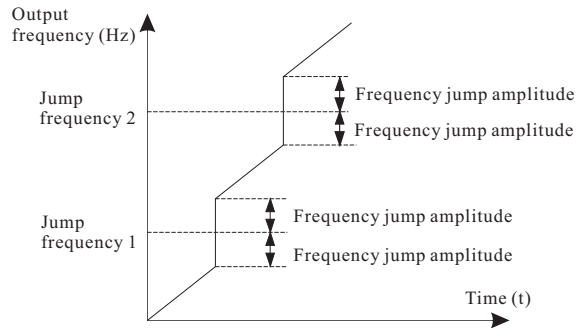

Figure 6-19 Diagram when the jump frequencies are valid during acceleration/deceleration

Function Code	Parameter Name	Setting Range	Default
F08.28	Frequency switch over point between acceleration time 1 and acceleration time 2	0.00Hz ~ F00.03(max. frequency)	0.00Hz
F08.29	Frequency switch over point between deceleration time 1 and deceleration time 2	0.00Hz ~ F00.03(max. frequency)	0.00Hz

This function is valid when motor 1 is selected and acceleration/deceleration time switch over is not performed by means of S terminal. It is used to select different groups of acceleration/deceleration time based on the running frequency range rather than S terminal during the running process of the AC drive.

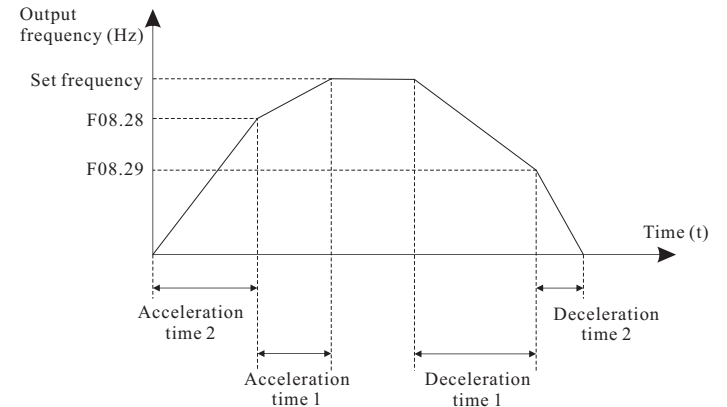

Figure 6-20 Acceleration/deceleration time switch over

During acceleration, if the running frequency is smaller than the value of F08.28, acceleration time 2 is selected. If the running frequency is larger than the value of F08.28, acceleration time 1 is selected.

During deceleration, if the running frequency is larger than the value of F08.29, deceleration time 1 is selected. If the running frequency is smaller than the value of F08.29, deceleration time 2 is selected.

Function Code	Parameter Name	Setting Range	Default
F08.30	Terminal JOG preferred	0: Disabled 1: Enabled	1

It is used to set whether terminal JOG is preferred.

If terminal JOG is preferred, the AC drive switches to terminal JOG running state when there is a terminal JOG command during the running process of the AC drive.

Function Code	Parameter Name	Setting Range	Default
F08.31	Any frequency reaching detection value 1	0.00 Hz to F00.03 (maximum frequency)	50.00Hz
F08.32	Any frequency reaching detection amplitude 1	0.0%~100.0% (maximum frequency)	0.0%
F08.33	Any frequency reaching detection value 2	0.00 Hz to F00.03 (maximum frequency)	50.00Hz
F08.34	Any frequency reaching detection amplitude 2	0.00 Hz to F00.03 (maximum frequency)	0.0%

If the output frequency of the AC drive is within the positive and negative amplitudes of the any frequency reaching detection value, the corresponding multi-function output becomes ON. The AC provides two groups of any frequency reaching detection parameters, including frequency detection value and detection amplitude, as shown in the following figure.

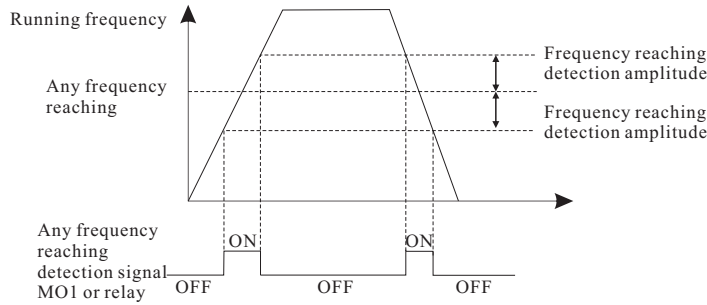

Figure 6-21 Any frequency reaching detection

Function Code	Parameter Name	Setting Range	Default
F08.35	Zero current detection level	0.0% ~ 300.0% (rated motor current)	5.0%
F08.36	Zero current detection delay time	0.01s ~ 600.00s	0.10s

If the output current of the AC drive is equal to or less than the zero current detection level and the duration exceeds the zero current detection delay time, the corresponding multi-function output terminal becomes ON.

The zero current detection is shown in the following figure:

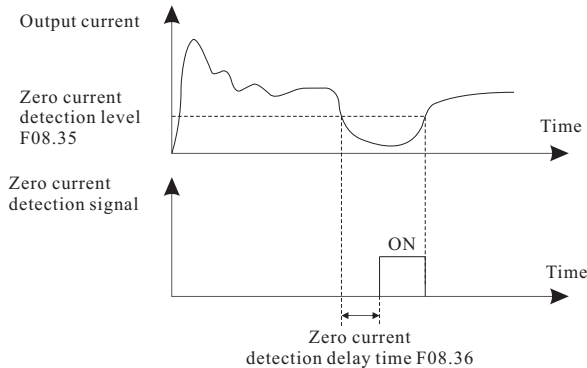

Figure 6-22 Zero current detection

Function Code	Parameter Name	Setting Range	Default
F08.37	Output overcurrent threshold	0.0% (no detection) 0.1%~300.0% (rated motor current)	200.0%
F08.38	Output overcurrent detection delay time	0.00s ~ 600.00s	0.00s

If the output current of the AC drive is equal to or higher than the overcurrent threshold and the duration exceeds the detection delay time, the corresponding multi-function output terminal becomes ON. The output overcurrent detection function is shown in the following figure.

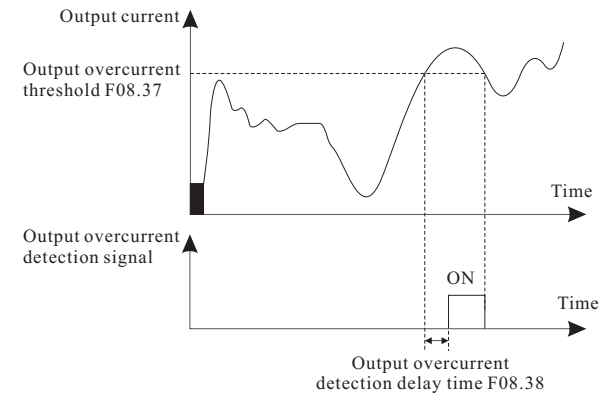

Figure 6-23 Output overcurrent detection

Function Code	Parameter Name	Setting Range	Default
F08.39	Any current reaching 1	0.0% ~ 300.0% (rated motor current)	100.0%
F08.40	Any current reaching 1 amplitude	0.0% ~ 300.0% (rated motor current)	0.0%
F08.41	Any current reaching 2	0.0% ~ 300.0% (rated motor current)	100.0%
F08.42	Any current reaching 2 amplitude	0.0% ~ 300.0% (rated motor current)	0.0%

If the output current of the AC drive is within the positive and negative amplitudes of any current reaching detection value, the corresponding multi-function output terminal becomes ON.

The drive provides two groups of any current reaching detection parameters, including current detection value and detection amplitudes, as shown in the following figure.

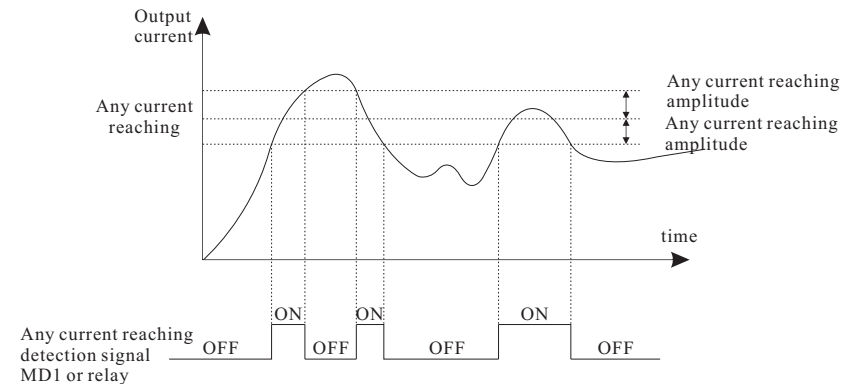

Figure 6-24 Any current reaching detection

Function Code	Parameter Name	Setting Range	Default
F08.43	Timing function	0: Disabled 1: Enabled	0
F08.44	Timing duration source	0: F08.45 1: analog AI1 2: analog AI2 3: analog AI3 (100% of analog input corresponds to the value of F8.45)	0
F08.45	Timing duration	0.0Min~6500.0Min	0.0Min

These parameters are used to implement the AC drive timing function. If F08.43 is set to 1, the AC drive starts to time at startup. When the set timing duration is reached, the AC drive stops automatically and meanwhile the corresponding multi-function terminal output becomes ON.

The AC drive starts timing from 0 each time it starts up and the remaining timing duration. The timing duration is set in F08.44 and F08.45, in unit of minute.

Function Code	Parameter Name	Setting Range	Default
F08.46	AI1 input voltage lower limit	0.00V~F08.47	3.10V
F08.47	AI1 input voltage upper limit	F08.46~10.00V	6.80V

These two parameters are used to set the limits of the input voltage to provide protection on the AC drive. When the AI1 input is larger than the value of F08.47 or smaller than the value of F08.46, the corresponding multi-function output terminal becomes ON, indicating that AI1 input exceeds the limit.

Function Code	Parameter Name	Setting Range	Default
F08.48	Module temperature threshold	0°C ~100°C	75°C

When the heatsink temperature of the AC drive reaches the value of this parameter, the corresponding multi-function output terminal becomes ON, indicating that the module temperature reaches the threshold.

Function Code	Parameter Name	Setting Range	Default
F08.49	Cooling fan control	0: Fan working during running 1: Fan working continuously	0

It is used to set the working mode of the cooling fan. If this parameter is set to 0, the fan works when the AC drive is in running state. When the AC drive stops, the cooling fan works if the heatsink temperature is higher than 40°C, and stops working if the heatsink temperature is lower than 40°C.

If this parameter is set to 1, the cooling fan keeps working after power-on.

Function Code	Parameter Name	Setting Range	Default
F08.50	Wakeup frequency	Dormant frequency (F8.52) to maximum frequency (F00.03)	0
F08.51	Wakeup delay time	0.0s~6500.0s	0.0s
F08.52	Dormant frequency	0.00 Hz to wakeup frequency (F08.50)	0.00Hz
F08.53	Dormant delay time	0.0s~6500.0s	0.0s

These parameters are used to implement the dormant and wakeup functions in the water supply application.

When the AC drive is in running state, the AC drive enters the dormant state and stops automatically after the dormant delay time (F08.53) if the set frequency is lower than or equal to the dormant frequency (F08.52).

When the AC drive is in dormant state and the current running command is effective, the AC drives starts up after the wakeup delay time (F08.51) if the set frequency is higher than or equal to the wakeup frequency (F08.50).

Generally, set the wakeup frequency equal to or higher than the dormant frequency. If the wakeup frequency and dormant frequency are set to 0, the dormant and wakeup functions are disabled.

When the dormant function is enabled, if the frequency source is PID, whether PID operation is performed in the dormant state is determined by F10-28. In this case, select PID operation enabled in the stop state (F10.28 = 1).

Function Code	Parameter Name	Setting Range	Default
F08.54	Current running time reached	0.0Min~6500.0Min	0.0Min

If the current running time reaches the value set in this parameter, the corresponding multi-function output terminal becomes ON, indicating that the current running time is reached.

Function Code	Parameter Name	Setting Range	Default
F08.55	DPWM switch over running frequency upper limit	0.00Hz~Max.frequency(F03.00)	8.00Hz

Only valid on V/F control.

Function Code	Parameter Name	Setting Range	Default
F08.56	PWM modulation system	0: asynchronous modulation 1: synchronous modulation	0

Only valid on V/F control.

Function Code	Parameter Name	Setting Range	Default
F08.57	Dead zone compensation mode selection	0: no compensation mode 1: compensation mode 1 2: compensation mode 2	1

This parameter is no need to modify normally, only if special request of output voltage wave, or motor oscillation.

High power suggest compensation modes 2.

Function Code	Parameter Name	Setting Range	Default
F08.58	Depth of PWM random	0: PWM random disabled 1~10: PWM carrier frequency random depth	0

This parameter can be used in soft motor voice and reduce electromagnetic interference.

Function Code	Parameter Name	Setting Range	Default
F08.59	Rapid current limit	0: Disabled 1: Enabled	1

This parameter can be used in overcurrent protection.

If rapid current limit long time, AC drive will overheat and cause drive damaged.

Function Code	Parameter Name	Setting Range	Default
F08.60	Current detection compensation	100~110	105

This parameter is no need to modify normally.

Function Code	Parameter Name	Setting Range	Default
F08.61	Under-voltage point	200V-1000V	Model dependent

Voltage class	Under-voltage point base value
Single phase 220V	200V
Three phase 220V	200V
Three phase 380V	350V
Three phase 480V	350V
Three phase 690V	650V
Three phase 1140V	1350V

Function Code	Parameter Name	Setting Range	Default
F08.62	SVC optimize mode selection	0 no optimize 1: optimize mode 1 2: optimize mode 2	1

Optimize mode 1: can be used in application need high torque control.

Optimize mode 2: can be used in application need high speed control.

Function Code	Parameter Name	Setting Range	Default
F08.63	Dead-zone time adjustment	100%~200%	150%

This parameter is only valid on 1140V and no need to modify normally.

Function Code	Parameter Name	Setting Range	Default
F08.64	Over-voltage point	200.0V~2500.0V	Model dependent

Voltage class	Under-voltage point base value
Single phase 220V	400.0V
Three phase 220V	400.0V
Three phase 380V	810.0V
Three phase 480V	890.0V
Three phase 690V	1300.0V
Three phase 1140V	2000.0V

Group F09: Fault and Protection

Function Code	Parameter Name	Setting Range	Default
F09.00	Input phase loss protection	0: disabled 1: enabled	1

It is used to determine whether to perform input phase loss or contactor energizing protection.

Drive $\geq 18.5\text{kW}$ G type drive provide the function of input phase loss protection.
 Drive $< 18.5\text{kW}$ P type drive do not provide the function of input phase loss protection no matter whether F09.00 is set to 0 or 1.

Function Code	Parameter Name	Setting Range	Default
F09.01	Output phase loss protection	0: Disabled 1: Enabled	1

It is used to determine whether to perform output phase loss protection.

Function Code	Parameter Name	Setting Range	Default
F09.02	Action selection at instantaneous power failure	0: Invalid 1: Decelerate 2: Decelerate to stop	0
F09.03	Voltage rally judging time at instantaneous power failure	0.00s~100.00s	0.50s
F09.04	Action judging voltage at instantaneous power failure	60.0% ~ 100.0%(standard bus voltage)	80.0%

Upon instantaneous power failure or sudden voltage dip, the DC bus voltage of the AC drive reduces. This function enables the AC drive to compensate the DC bus voltage reduction with the load feedback energy by reducing the output frequency so as to keep the AC drive running continuously.

- If F09.02 = 1, upon instantaneous power failure or sudden voltage dip, the AC drive decelerates. Once the bus voltage resumes to normal, the AC drive accelerates to the set frequency. If the bus voltage remains normal for the time exceeding the value set in F09.03, it is considered that the bus voltage resumes to normal.

- If F09.02 = 2, upon instantaneous power failure or sudden voltage dip, the AC drive decelerates to stop.

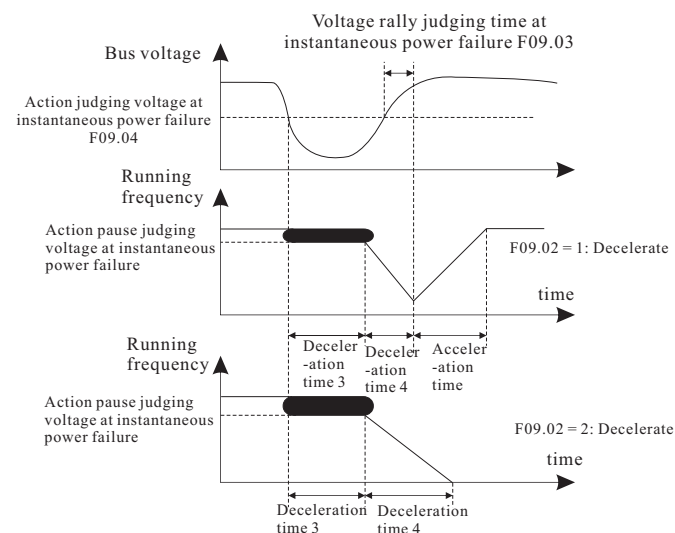

Figure 6-25 AC drive action diagram upon instantaneous power failure

Function Code	Parameter Name	Setting Range	Default
F09.05	Overvoltage stall gain	0~100	30
F09.06	Overvoltage stall protective voltage	200.0V-2000.0V	Model dependent

When the DC bus voltage exceeds the value of F09.06 (Overvoltage stall protective voltage) during deceleration of the AC drive, the AC drive stops deceleration and keeps the present running frequency. After the bus voltage declines, the AC drive continues to decelerate. F09.05 (Overvoltage stall gain) is used to adjust the overvoltage suppression capacity of the AC drive. The larger the value is, the greater the overvoltage suppression capacity will be.

In the prerequisite of no overvoltage occurrence, set F09.05 to a small value. For small-inertia load, the value should be small. Otherwise, the system dynamic response will be slow. For large-inertia load, the value should be large. Otherwise, the suppression result will be poor and an overvoltage fault may occur. If the overvoltage stall gain is set to 0, the overvoltage stall function is disabled.

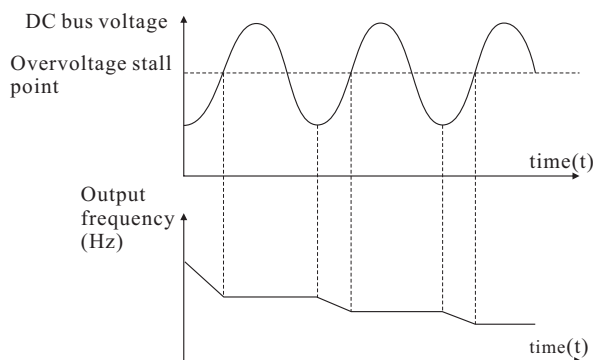

Figure 6-26 Diagram of the overvoltage stall protection function

Function Code	Parameter Name	Setting Range	Default
F09.07	Overcurrent stall gain	0~100	20
F09.08	Overcurrent stall protective current	100%~200%	150%

When the output current exceeds the overcurrent stall protective current during acceleration/deceleration of the AC drive, the AC drive stops acceleration/deceleration and keeps the present running frequency. After the output current declines, the AC drive continues to accelerate/decelerate.

F09.07(Overcurrent stall gain) is used to adjust the overcurrent suppression capacity of the AC drive. The larger the value is, the greater the overcurrent suppression capacity will be. In the prerequisite of no overcurrent occurrence, set F09.08 to a small value.

For small-inertia load, the value should be small. Otherwise, the system dynamic response will be slow. For large-inertia load, the value should be large. Otherwise, the suppression result will be poor and overcurrent fault may occur.

If the overcurrent stall gain is set to 0, the overcurrent stall function is disabled.

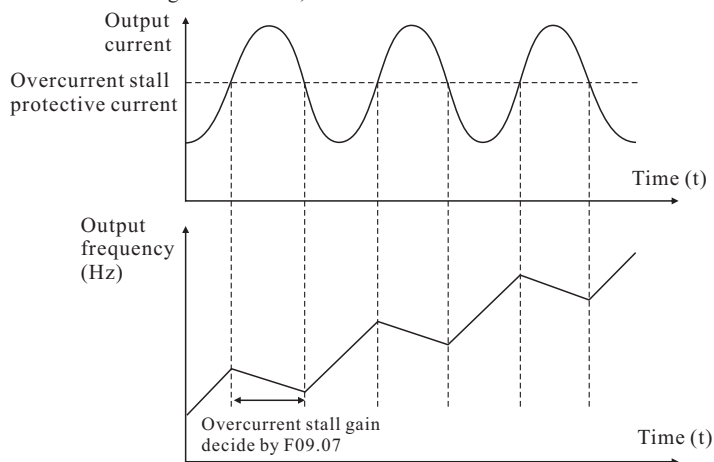

Figure 6-27 Diagram of the overcurrent stall protection function

Function Code	Parameter Name	Setting Range	Default
F09.09	Motor overload warning selection	0: disabled 1: enabled	1

F09.09=0: no motor overload protection, it will cause motor overheat and damaged, we suggest to use thermal relay.

F09.09=1: motor overload protection according to inverse time limit curve.

Function Code	Parameter Name	Setting Range	Default
F09.10	Motor overload pre-alarm warning detection levels	0.20~10.00	1.00
F09.11	Motor overload pre-alarm warning detection time	50%~100%	80%

Function Code	Parameter Name	Setting Range	Default
F09.12	Protection upon load becoming 0	0: disabled 1: enabled	0
F09.13	Detection level of load becoming 0	0.0 ~ 100.0% (rated motor current)	10.0%
F09.14	Detection time of load becoming 0	0.0~60.0s	1.0s

If protection upon load becoming 0 is enabled, when the output current of the AC drive is lower than the detection level (F09.13) and the lasting time exceeds the detection time (F09.14), the output frequency of the AC drive automatically declines to 7% of the rated frequency. During the protection, the AC drive automatically accelerates to the set frequency if the load resumes to normal.

Function Code	Parameter Name	Setting Range	Default
F09.15	Over-speed detection value	0.0% ~ 50.0%(F00.03(max.frequency))	20.0%
F09.16	Over-speed detection time	0.0~60.0s	1.0s

This function is valid only when the AC drive runs in the sensor vector control mode. If the actual motor rotational speed detected by the AC drive exceeds the maximum frequency and the excessive value is greater than the value of F09.15 and the lasting time exceeds the value of F09.16, the AC drive reports E035 and acts according to the selected fault protection action.

Function Code	Parameter Name	Setting Range	Default
F09.17	Detection value of too large speed deviation	0.0%~50.0%(F00.03(max.frequency))	20.0%
F09.18	Detection time of too large speed deviation	0.0s~60.0s	5.0s

This function is valid only when the AC drive runs in the sensor vector control mode.

If the AC drive detects the deviation between the actual motor rotational speed detected by the AC drive and the set frequency is greater than the value of F09.17 and the lasting time exceeds the value of F09.18, the AC drive reports E034 and according to the selected fault protection action.

If F09.18 (Detection time of too large speed deviation) is 0.0s, this function is disabled.

Function Code	Parameter Name	Setting Range	Default
F09.19	Fault auto reset times	0~20	0

It is used to set the times of fault auto resets if this function is used. After the value is exceeded, the AC drive will remain in the fault state.

Function Code	Parameter Name	Setting Range	Default
F09.20	Time interval of fault auto reset	0.1s~100.0s	1.0s

It is used to set the waiting time from the alarm of the AC drive to fault auto reset.

Function Code	Parameter Name	Setting Range	Default
F09.21	Fault protection action selection 1	Unit's digit: motor overload (E007) 0: coast to stop 1: stop according to the stop mode 2: continue to run Ten's digit: power input phase loss (E012) Hundred's digit: power output phase loss (E013) Thousand's digit: external equipment fault (E00d) Ten thousand's digit: communication fault (E018)	0000
F09.22	Fault protection action selection 2	Unit's digit: encoder/PG card fault (E026) 0: coast to stop Ten's digit: EEPROM read-write fault (E021) 0: coast to stop 1: stop according to the stop mode Hundred's digit: reserved Thousand's digit: motor overheat (E036) Ten thousand's digit (Accumulative running time reached) (E020)	0000

Function Code	Parameter Name	Setting Range	Default
F09.23	Fault protection action selection 3	Unit's digit reserved Ten's digit: reserved Hundred's digit (Accumulative power-on time reached) (E029) 0: coast to stop 1: stop according to the stop mode 2: continue to run Thousand's digit: off load (E030) 0: coast to stop 1: decelerate to stop 2: continue to run at 7% of rated motor frequency and resume to the set frequency if the load recovers	0000
F09.24	Fault protection action selection 4	Unit's digit: too large speed deviation (E034) 0: coast to stop 1: stop according to the stop mode 2: continue to run Ten's digit: motor over-speed (E035) Hundred's digit: initial position fault (E037)	0000

If "Coast to stop" is selected, the AC drive displays E0** and directly stops.

• If "Stop according to the stop mode" is selected, the AC drive displays A** and stops according to the stop mode. After stop, the AC drive displays E0**.

• If "Continue to run" is selected, the AC drive continues to run and displays A**. The running frequency is set in F09.26.

Function Code	Parameter Name	Setting Range	Default
F09.26	Frequency selection for continuing to run upon fault	0: Current running frequency 1: Set frequency 2: Frequency upper limit 3: Frequency lower limit 4: Backup frequency upon abnormality	0

If a fault occurs during the running of the AC drive and the handling of fault is set to "Continue to run", the AC drive displays A** and continues to run at the frequency set in F09.26.

Function Code	Parameter Name	Setting Range	Default
F09.27	Current fault type	0~32	-
F09.28	2nd fault type		-
F09.29	1st fault type		-

It is used to record the types of the most recent three faults of the AC drive. 0 indicates no fault. For possible causes and solution of each fault, refer to Chapter 8.

Function Code	Parameter Name	Setting Range	Default										
F09.30	Frequency upon current fault	It displays the frequency when the latest fault occurs	-										
F09.31	Output current upon current fault	It displays the current when the latest fault occurs.	-										
F09.32	Bus voltage upon current fault	It displays the bus voltage when the latest fault occurs.	-										
F09.33	Input terminal status upon current fault	It displays the status of all digital input terminals when the latest fault occurs. The sequence is as follows: <table border="1" style="margin-left: 20px;"> <tr> <td>BIT9</td><td>BIT8</td><td>BIT7</td><td>BIT6</td><td>BIT5</td><td>BIT4</td><td>BIT3</td><td>BIT2</td><td>BIT1</td><td>BIT0</td> </tr> </table> HDI S9 S8 S7 S6 S5 S4 S3 S2 S1 If a input terminal is ON, the setting is 1. If the DI is OFF, the setting is 0. The value is the equivalent decimal number converted from the S status..	BIT9	BIT8	BIT7	BIT6	BIT5	BIT4	BIT3	BIT2	BIT1	BIT0	-
BIT9	BIT8	BIT7	BIT6	BIT5	BIT4	BIT3	BIT2	BIT1	BIT0				
F09.34	Output terminal status upon current fault	It displays the status of all output terminals when the latest fault occurs. The sequence is as follows: <table border="1" style="margin-left: 20px;"> <tr> <td>BIT4</td><td>BIT3</td><td>BIT2</td><td>BIT1</td><td>BIT0</td> </tr> </table> DO2 MO1 RA TA FMP If an output terminal is ON, the setting is 1. If the output terminal is OFF, the setting is 0. The value is the equivalent decimal number converted from the S statuses.	BIT4	BIT3	BIT2	BIT1	BIT0	-					
BIT4	BIT3	BIT2	BIT1	BIT0									
F09.35	AC drive status upon current fault	Reserved	-										
F09.36	Power-on time status upon current fault	It displays the present power-on time when the latest fault occurs	-										
F09.37	Running time status upon current fault	It displays the present running time when the latest fault occurs.	-										

Function Code	Parameter Name	Setting Range	Default
F09.38	Frequency upon 2nd fault	Same as F09.30~F09.37	-
F09.39	Output current upon 2nd fault		-
F09.40	Bus voltage upon 2nd fault		-
F09.41	Input terminal status upon 2nd fault		-
F09.42	Output terminal status upon 2nd fault		-
F09.43	AC drive status upon 2nd fault		-
F09.44	Power-on time upon 2nd fault		-
F09.45	Running time upon 2nd fault		-
F09.46	Frequency upon 1st fault		-
F09.47	Output current upon 1st fault		-
F09.48	Bus voltage upon 1st fault		-
F09.49	Input terminal status upon 1st fault		-
F09.50	Output terminal status upon 1st fault		-
F09.51	AC drive status upon 1st fault	-	
F09.52	Power-on time upon 1st fault	-	
F09.53	Running time upon 1st fault	-	

Function Code	Parameter Name	Setting Range	Default
F09.54	Short-circuit to ground upon power-on	0: Disabled 1: Enabled	1

It is used to determine whether to check the motor is short-circuited to ground at power-on of the AC drive. If this function is enabled, the AC drive's UVW will have voltage output a while after power-on.

Function Code	Parameter Name	Setting Range	Default
F09.55	Output terminal action during fault auto reset	0: Not act 1: Act	0

Set by F09.55.

Function Code	Parameter Name	Setting Range	Default
F09.56	Backup frequency upon abnormality	0.0%~ 100.0% (100.0% corresponding to maximum frequency)F00.03	100.0%

Function Code	Parameter Name	Setting Range	Default
F09.57	Type of motor temperature sensor	0: No temperature sensor 1: PT100 2: PT1000	0
F09.58	Motor overheat protection threshold	0°C ~200°C	110°C
F09.59	Motor overheat warning threshold	0°C ~200°C	90°C

The signal of the motor temperature sensor needs to be connected to the multi-function analog input terminal. Analog input AI3 can be used for the temperature signal input. The motor temperature sensor is connected to AI3 and ACM terminal. The AI3 terminal of the drive supports both PT100 and PT1000. Set the sensor type correctly during the use.

If the motor temperature exceeds the value set in F09.58, the AC drive reports an alarm and acts according to the selected fault protection action.

If the motor temperature exceeds the value set in F09.59, motor overheat warning becomes ON.

Function Code	Parameter Name	Setting Range	Default
F09.60	Action pause judging voltage at instantaneous power failure	F09.04~100.0%	90.0%
F09.61	Brake unit work starting voltage	650V-800V	760V

Group F10: Process Control PID Function

PID control is a general process control method. By performing proportional, integral and differential operations on the difference between the feedback signal and the target signal, it adjusts the output frequency and constitutes a feedback system to stabilize the controlled counter around the target value.

It is applied to process control such as flow control, pressure control and temperature control. The following figure shows the principle block diagram of PID control.

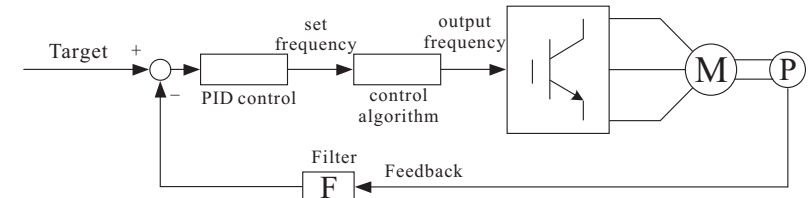

Figure 6-28 Principle block diagram of PID control

Function Code	Parameter Name	Setting Range	Default
F10.00	PID setting source	0: Keypad (F10.01) 1: Analog AI1 2: Analog AI2 3: Analog AI3 4: Pulse setting (HDI) 5: Rs485 communication setting 6: Multi-speed command	0
F10.01	PID digital setting	0.0~100.0%	50.0%

F00.06 is used to select the channel of target process PID setting. The PID setting is a relative value and ranges from 0.0% to 100.0%. The PID feedback is also a relative value. The purpose of PID control is to make the PID setting and PID feedback equal.

Function Code	Parameter Name	Setting Range	Default
F10.02	PID feedback source	0: AI1 1: AI2 2: AI3 3: AI1 – AI2 4: Pulse setting (HDI) 5: Rs485 communication setting 6: AI1 + AI2 7: MAX (AI1 , AI2) 8: MIN (AI1 , AI2)	0

This parameter is used to select the feedback signal channel of process PID. The PID feedback is a relative value and ranges from 0.0% to 100.0%.

Function Code	Parameter Name	Setting Range	Default
F10.03	PID output characteristic	0 : positive 1 : negative	0

• 0 : positive

When the feedback value is smaller than the PID setting, the AC drive's output frequency rises. For example, the winding tension control requires forward PID action.

• 1 : negative

When the feedback value is smaller than the PID setting, the AC drive's output frequency reduces. For example, the unwinding tension control requires reverse PID action.

Function Code	Parameter Name	Setting Range	Default
F10.04	PID setting feedback range	0~65535	1000

This parameter is a non-dimensional unit. It is used for PID setting display and PID feedback display.

Relative value 100% of PID setting feedback corresponds to the value of F10.04.

Function Code	Parameter Name	Setting Range	Default
F10.05	Proportional gain Kp1	0.0~100.0	20.0
F10.06	Integral time Ti1	0.01s~10.00s	2.00s
F10.07	Differential time Td1	0.000s~10.000s	0.000s

• F10.05 (Proportional gain Kp1)

It decides the regulating intensity of the PID regulator. The higher the Kp1 is, the larger the regulating intensity is. The value 100.0 indicates when the deviation between PID feedback and PID setting is 100.0%, the adjustment amplitude of the PID regulator on the output frequency reference is the maximum frequency.

• F10.06 (Integral time Ti1)

It decides the integral regulating intensity. The shorter the integral time is, the larger the regulating intensity is. When the deviation between PID feedback and PID setting is 100.0%, the integral regulator performs continuous adjustment for the time set in F10.06. Then the adjustment amplitude reaches the maximum frequency.

• F10.07 (Differential time Td1)

It decides the regulating intensity of the PID regulator on the deviation change. The longer the differential time is, the larger the regulating intensity is. Differential time is the time within which the feedback value change reaches 100.0%, and then the adjustment amplitude reaches the maximum frequency.

Function Code	Parameter Name	Setting Range	Default
F10.08	Cut-off frequency of PID reverse rotation	0.00 ~ F00.03(maximum frequency)	0.00Hz

In some situations, only when the PID output frequency is a negative value (AC drive reverse rotation), PID setting and PID feedback can be equal. However, too high reverse rotation frequency is prohibited in some applications, and F10.08 is used to determine the reverse rotation frequency upper limit.

Function Code	Parameter Name	Setting Range	Default
F10.09	PID deviation limit	0.0%~100.0%	0.0%

If the deviation between PID feedback and PID setting is smaller than the value of F10.09, PID control stops. The small deviation between PID feedback and PID setting will make the output frequency stabilize, effective for some closed-loop control applications.

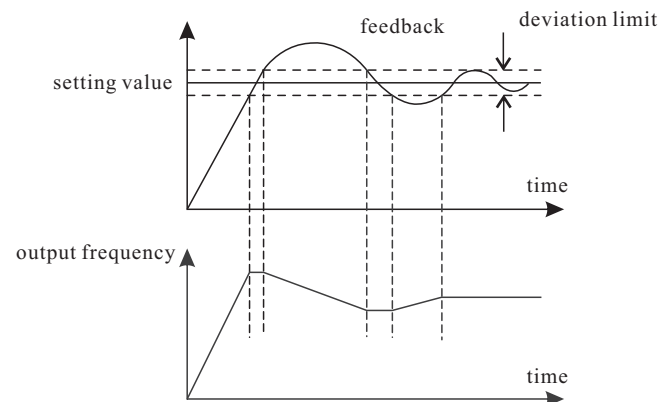

Figure 6-29 relation between deviation limit and output frequency

Function Code	Parameter Name	Setting Range	Default
F10.10	PID differential limit	0.00%~100.00%	0.10%

It is used to set the PID differential output range. In PID control, the differential operation may easily cause system oscillation. Thus, the PID differential regulation is restricted to a small range.

Function Code	Parameter Name	Setting Range	Default
F10.11	PID setting change time	0.00~650.00s	0.00s

The PID setting change time indicates the time required for PID setting changing from 0.0% to 100.0%. The PID setting changes linearly according to the change time, reducing the impact caused by sudden setting change on the system.

Function Code	Parameter Name	Setting Range	Default
F10.12	PID feedback filter time	0.00~60.00s	0.00s
F10.13	PID output filter time	0.00~60.00s	0.00s

F10.12 is used to filter the PID feedback, helping to reduce interference on the feedback but slowing the response of the process closed-loop system.

F10.13 is used to filter the PID output frequency, helping to weaken sudden change of the AC drive output frequency but slowing the response of the process closed-loop system.

Function Code	Parameter Name	Setting Range	Default
F10.15	Proportional gain Kp2	0.0~100.0	20.0
F10.16	Integral time Ti2	0.01s~10.00s	2.00s
F10.17	Differential time Td2	0.000s~10.000s	0.000s
F10.18	PID parameter switch over condition	0: No switch over 1: Switch over via input terminal 2: Automatic switch over based on deviation	0
F10.19	PID parameter switch over deviation 1	0.0%~F10.20	20.0%
F10.20	PID parameter switch over deviation 2	F10.19~100.0%	80.0%

In some applications, PID parameters switch over is required when one group of PID parameters cannot satisfy the requirement of the whole running process.

These parameters are used for switch over between two groups of PID parameters. Regulator parameters F10.15 to F10.17 are set in the same way as F10.05 to F10.07.

The switch over can be implemented either via a S terminal or automatically implemented based on the deviation.

If you select switch over via a S terminal, the multi-function terminal must be allocated with function 43 "PID parameter switch over". If the multi-function terminal is OFF, group 1 (F10.05 to F10.07) is selected. If the multi-function terminal is ON, group 2 (F10.15 to F10.17) is selected.

If you select automatic switch over, when the absolute value of the deviation between PID feedback and PID setting is smaller than the value of F10.19, group 1 is selected. When the absolute value of the deviation between PID feedback and PID setting is higher than the value of F10.20, group 2 is selected. When the deviation is between F10.19 and F10.20, the PID parameters are the linear interpolated value of the two groups of parameter values.

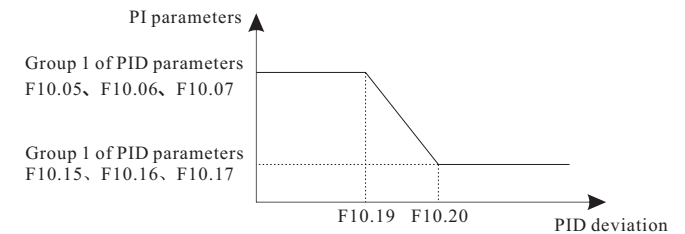

Figure 6-30 PID parameters switch over

Function Code	Parameter Name	Setting Range	Default
F10.21	PID initial value	0.0%~100.0%	0.0%
F10.22	PID initial value holding time	0.00~650.00s	0.00s

When the AC drive starts up, the PID starts closed-loop algorithm only after the PID output is fixed to the PID initial value (F10.21) and lasts the time set in F10.22.

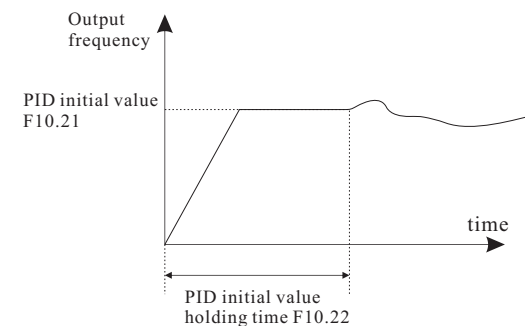

Figure 6-31 PID initial value function

Function Code	Parameter Name	Setting Range	Default
F10.23	Maximum deviation between two PID outputs in forward direction	0.00%~100.00%	1.00%
F10.24	Maximum deviation between two PID outputs in reverse direction	0.00%~100.00%	1.00%

F10.23 and F10.24 respectively correspond to the maximum absolute value of the output deviation in forward direction and in reverse direction.

Function Code	Parameter Name	Setting Range	Default
F10.25	PID integral property	Unit's digit :Integral separated 0: Invalid 1: Valid Ten's digit :Whether to stop integral operation when the output reaches the limit 0: Continue integral operation 1: Stop integral operation	00

• Integral separated

If it is set to valid, the PID integral operation stops when the multi-function digital S allocated with function 22 "PID integral pause" is ON In this case, only proportional and differential operations take effect.

If it is set to invalid, integral separated remains invalid no matter whether the S allocated with function 22 "PID integral pause" is ON or not.

• Whether to stop integral operation when the output reaches the limit.

If "Stop integral operation" is selected, the PID integral operation stops, which may help to reduce the PID overshoot.

Function Code	Parameter Name	Setting Range	Default
F10.26	Detection value of PID feedback loss	0.0%: Not judging feedback loss 0.1%~100.0%	0.0%
F10.27	Detection time of PID feedback loss	0.0s~20.0s	0.0s

These parameters are used to judge whether PID feedback is lost.

If the PID feedback is smaller than the value of F10.26 and the lasting time exceeds the value of F10.27, the AC drive reports E02E and acts according to the selected fault protection action.

Function Code	Parameter Name	Setting Range	Default
F10.28	PID operation at stop	0: No PID operation at stop 1: PID operation at stop	1

It is used to select whether to continue PID operation in the state of stop. Generally, the PID operation stops when the AC drive stops.

Group F11: Swing Frequency, Fixed Length and Count

The swing frequency function is applied to the textile and chemical fiber fields and the applications where traversing and winding functions are required. The swing frequency function indicates that the output frequency of the AC drive swings up and down with the set frequency as the center. The trace of running frequency at the time axis is shown in the following figure. The swing amplitude is set in F11.00 and F11.01. When F11.01 is set to 0, the swing amplitude is 0 and the swing frequency does not take effect.

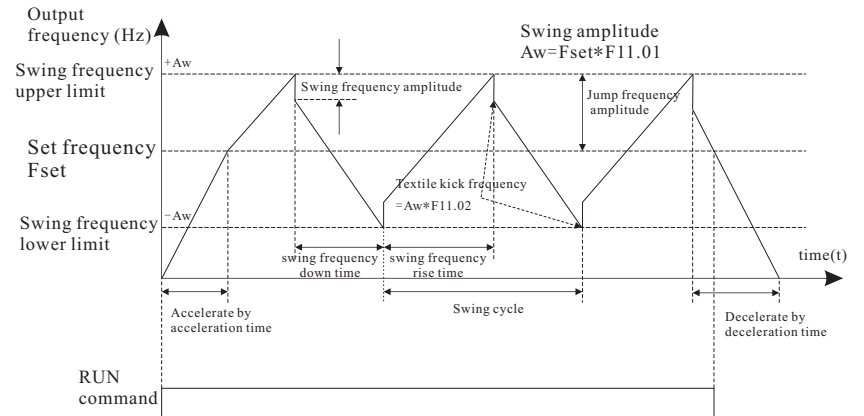

Figure 6-32 Swing frequency control

Function Code	Parameter Name	Setting Range	Default
F11.00	Swing frequency setting mode	0: Relative to the central frequency 1: Relative to the maximum frequency	0

This parameter is used to select the base value of the swing amplitude.

- 0: Relative to the central frequency (F00.09 frequency source selection)

It is variable swing amplitude system. The swing amplitude varies with the central frequency (set frequency).

- 1: Relative to the maximum frequency (F00.03 maximum output frequency)

It is fixed swing amplitude system. The swing amplitude is fixed.

Function Code	Parameter Name	Setting Range	Default
F11.01	Swing frequency amplitude	0.0%~100.0%	0.0%
F11.02	Jump frequency amplitude	0.0%~50.0%	0.0%

This parameter is used to determine the swing amplitude and jump frequency amplitude.

The swing frequency is limited by the frequency upper limit and frequency lower limit.

- If relative to the central frequency (F11.00 = 0), the actual swing amplitude AW is the calculation result of frequency source selection multiplied by F11.00.
- If relative to the maximum frequency (F11.00 = 1), the actual swing amplitude AW is the calculation result of maximum frequency multiplied by F11.00.

Jump frequency = Swing amplitude AW x FB-02 (Jump frequency amplitude).

- If relative to the central frequency (F11.00 = 0), the jump frequency is a variable value.
- If relative to the maximum frequency (F11.00 = 1), the jump frequency is a fixed value.

The swing frequency is limited by the frequency upper limit and frequency lower limit.

Function Code	Parameter Name	Setting Range	Default
F11.03	Swing frequency cycle	0.1s~3000.0s	10.0s
F11.04	Triangular wave rising time coefficient	0.1%~100.0%	50.0%

F11.03 specifies the time of a complete swing frequency cycle.
 F11.04 specifies the time percentage of triangular wave rising time to F11.03 (Swing frequency cycle).
 • Triangular wave rising time = F11.03 (Swing frequency cycle) x F11.04 (Triangular wave rising time coefficient, unit: s)
 • Triangular wave falling time = F11.03 (Swing frequency cycle) x (1 - F11.04 Triangular wave rising time coefficient, unit: s)

Function Code	Parameter Name	Setting Range	Default
F11.05	Set length	0m~65535m	1000m
F11.06	Actual length	0m~65535m	0m
F11.07	Number of pulses per meter	0.1~6553.5	100.0

The preceding parameters are used for fixed length control.
 The length information is collected by multi-function digital input(DI) terminals. F11.06 (Actual length) is calculated by dividing the number of pulses collected by the DI terminal by F11.07 (Number of pulses each meter).

When the actual length F11.06 exceeds the set length in F11.05, the multi-function digital output terminal allocated becomes ON.
 During the fixed length control, the length reset operation can be performed via the multi-function S terminal allocated with function 28. For details, see the descriptions of F05.00 to F05.09.

Allocate corresponding input terminal with function 27 (Length count input) in applications. If the pulse frequency is high, HDI must be used.

Function Code	Parameter Name	Setting Range	Default
F11.08	Set count value	1~65535	1000
F11.09	Designated count value	1~65535	1000

The count value needs to be collected by input terminal. Allocate the corresponding input terminal with function 25 (Counter input) in applications. If the pulse frequency is high, HDI must be used.
 When the count value reaches the set count value (F11.08), multi-function digital output terminal allocated with function 8 (Set count value reached) becomes ON. Then the counter stops counting.
 When the counting value reaches the designated counting value (F11.09), multi-function digital output terminal allocated with function 9 (Designated count value reached) becomes ON. Then the counter continues to count until the set count value is reached.

F11.09 should be equal to or smaller than F11.08.

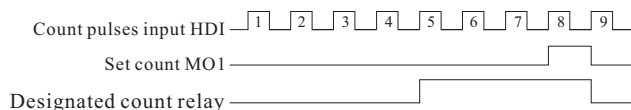

Figure 6-33 Reaching the set count value and designated count value

Group F12: Simple PLC Function And Multi-speed control

The drive multi-command has many functions. Besides multi-speed, it can be used as the setting source of the V/F separated voltage source and setting source of process PID. In addition, the multi-command is relative value.

The simple PLC function is different from the drive user programmable function. Simple PLC can only complete simple combination of multi-command, while the user programmable function is more practical.

Function Code	Parameter Name	Setting Range	Default
F12.00	Simple PLC running mode	0: Stop after the AC drive runs one cycle 1: Keep final values after the AC drive runs one cycle 2: Repeat after the AC drive runs one cycle	0

Simple PLC can be either the frequency source or V/F separated voltage source.

When simple PLC is used as the frequency source, whether parameter values of F12.02 to F12.17 are positive or negative determines the running direction. If the parameter values are negative, it indicates that the AC drive runs in reverse direction.

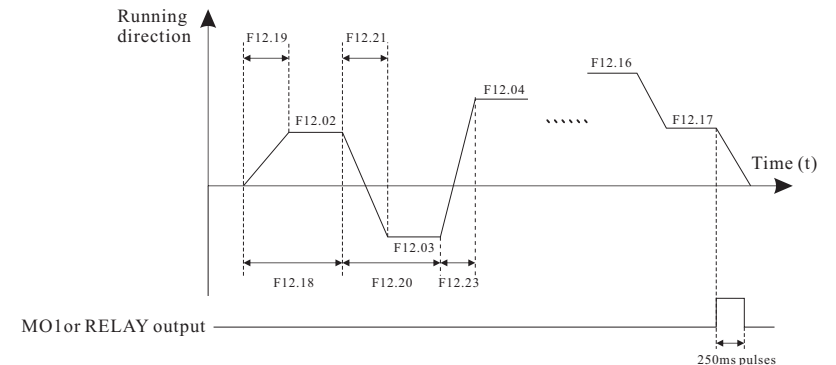

Figure 6-34 Simple PLC when used as frequency source

- 0: Stop after the AC drive runs one cycle
The AC drive stops after running one cycle, and will not start up until receiving another command.
- 1: Keep final values after the AC drive runs one cycle
The AC drive keeps the final running frequency and direction after running one cycle.
- 2: Repeat after the AC drive runs one cycle
The AC drive automatically starts another cycle after running one cycle, and will not stop until receiving the stop command.

Function Code	Parameter Name	Setting Range	Default
F12.01	Simple PLC retentive selection	Unit's digit :Retentive upon power failure 0: No 1: Yes Ten's digit :Retentive upon stop 0: No 1: Yes	00

PLC retentive upon power failure indicates that the AC drive memorizes the PLC running moment and running frequency before power failure and will continue to run from the memorized moment after it is powered on again. If the unit's digit is set to 0, the AC drive restarts the PLC process after it is powered on again.

PLC retentive upon stop indicates that the AC drive records the PLC running moment and running frequency upon stop and will continue to run from the recorded moment after it starts up again. If the ten's digit is set to 0, the AC drive restarts the PLC process after it starts up again.

Function Code	Parameter Name	Setting Range	Default
F12.02	Multi-speed 0	-100.0%~100.0%	0.0%
F12.03	Multi-speed 1	-100.0%~100.0%	0.0%
F12.04	Multi-speed 2	-100.0%~100.0%	0.0%
F12.05	Multi-speed 3	-100.0%~100.0%	0.0%
F12.06	Multi-speed 4	-100.0%~100.0%	0.0%
F12.07	Multi-speed 5	-100.0%~100.0%	0.0%
F12.08	Multi-speed 6	-100.0%~100.0%	0.0%
F12.09	Multi-speed 7	-100.0%~100.0%	0.0%
F12.10	Multi-speed 8	-100.0%~100.0%	0.0%
F12.11	Multi-speed 9	-100.0%~100.0%	0.0%
F12.12	Multi-speed 10	-100.0%~100.0%	0.0%
F12.13	Multi-speed 11	-100.0%~100.0%	0.0%
F12.14	Multi-speed 12	-100.0%~100.0%	0.0%
F12.15	Multi-speed 13	-100.0%~100.0%	0.0%
F12.16	Multi-speed 14	-100.0%~100.0%	0.0%
F12.17	Multi-speed 15	-100.0%~100.0%	0.0%

Multi-command can be the setting source of frequency, V/F separated voltage and process PID. The multi-command is relative value and ranges from -100.0% to 100.0%.

As frequency source, it is a percentage relative to the maximum frequency. As V/F separated voltage source, it is a percentage relative to the rated motor voltage. As process PID setting source, it does not require conversion.

Multi-command can be switched over based on different states of multi-function digital S terminals. For details, see the descriptions of group F05.

Function Code	Parameter Name	Setting Range	Default
F12.18	Running time of simple PLC multi-speed 0	0.0s(h)~6500.0s(h)	0.0s(h)
F12.19	Acceleration/deceleration time of simple PLC multi-speed 0	0~3	0
F12.20	Running time of simple PLC multi-speed 1	0.0s(h)~6500.0s(h)	0.0s(h)
F12.21	Acceleration/deceleration time of simple PLC multi-speed 1	0~3	0
F12.22	Running time of simple PLC multi-speed 2	0.0s(h)~6500.0s(h)	0.0s(h)
F12.23	Acceleration/deceleration time of simple PLC multi-speed 2	0~3	0
F12.24	Running time of simple PLC multi-speed 3	0.0s(h)~6500.0s(h)	0.0s(h)
F12.25	Acceleration/deceleration time of simple PLC multi-speed 3	0~3	0
F12.26	Running time of simple PLC multi-speed 4	0.0s(h)~6500.0s(h)	0.0s(h)
F12.27	Acceleration/deceleration time of simple PLC multi-speed 4	0~3	0
F12.28	Running time of simple PLC multi-speed 5	0.0s(h)~6500.0s(h)	0.0s(h)
F12.29	Acceleration/deceleration time of simple PLC multi-speed 5	0~3	0
F12.30	Running time of simple PLC multi-speed 6	0.0s(h)~6500.0s(h)	0.0s(h)
F12.31	Acceleration/deceleration time of simple PLC multi-speed 6	0~3	0
F12.32	Running time of simple PLC multi-speed 7	0.0s(h)~6500.0s(h)	0.0s(h)
F12.33	Acceleration/deceleration time of simple PLC multi-speed 7	0~3	0
F12.34	Running time of simple PLC multi-speed 8	0.0s(h)~6500.0s(h)	0.0s(h)
F12.35	Acceleration/deceleration time of simple PLC multi-speed 8	0~3	0
F12.36	Running time of simple PLC multi-speed 9	0.0s(h)~6500.0s(h)	0.0s(h)

Function Code	Parameter Name	Setting Range	Default
F12.37	Acceleration/deceleration time of simple PLC multi-speed 9	0~3	0
F12.38	Running time of simple PLC multi-speed 10	0.0s(h)~6500.0s(h)	0.0s(h)
F12.39	Acceleration/deceleration time of simple PLC multi-speed 10	0~3	0
F12.40	Running time of simple PLC multi-speed 11	0.0s(h)~6500.0s(h)	0.0s(h)
F12.41	Acceleration/deceleration time of simple PLC multi-speed 11	0~3	0
F12.42	Running time of simple PLC multi-speed 12	0.0s(h)~6500.0s(h)	0.0s(h)
F12.43	Acceleration/deceleration time of simple PLC multi-speed 12	0~3	0
F12.44	Running time of simple PLC multi-speed 13	0.0s(h)~6500.0s(h)	0.0s(h)
F12.45	Acceleration/deceleration time of simple PLC multi-speed 13	0~3	0
F12.46	Running time of simple PLC multi-speed 14	0.0s(h)~6500.0s(h)	0.0s(h)
F12.47	Acceleration/deceleration time of simple PLC multi-speed 14	0~3	0
F12.48	Running time of simple PLC multi-speed 15	0.0s(h)~6500.0s(h)	0.0s(h)
F12.49	Acceleration/deceleration time of simple PLC multi-speed 15	0~3	0
F12.50	Time unit of multi-speed	0: s (second) 1:h (hour)	0
F12.51	Multi-speed 0 source	0: Set by F12.02 1: AI1 2: AI2 3: AI3 4: Pulse setting 5: PID 6: Set frequency via keypad (F00.10), modified UP/DOWN	0

It determines the setting channel of reference 0. You can perform convenient switch over between the setting channels. When multi-command or simple PLC is used as frequency source, the switch over between two frequency sources can be realized easily.

Group F13: Communication Parameters

Function Code	Parameter Name	Setting Range	Default
F13.00	Local address	1 ~ 247, 0 is broadcast address	1

Function Code	Parameter Name	Setting Range	Default
F13.01	Baud rate	0: 300BPS 1: 600BPS 2: 1200BPS 3: 2400BPS 4: 4800BPS 5: 9600BPS 6: 19200BPS 7: 38400BPS 8: 57600BPS 9: 115200BPS	5

This parameter is used on set data transfer rate between host computer and AC drive.

Note: Baud rate of host computer and AC drive must be same, or communication is failed. The higher baud rate, the faster communication speed.

Function Code	Parameter Name	Setting Range	Default
F13.02	Data format	0: No check, data format (8,N,2) 1: Even parity check, data format (8,E,1) 2: Odd Parity check, data format (8,O,1) 3: Data format (8,N,1)	3

Note: Data format of host computer and AC drive must be same, or communication is failed.

Function Code	Parameter Name	Setting Range	Default
F13.03	Response delay	0~20ms	20ms

Function Code	Parameter Name	Setting Range	Default
F13.04	Communication timeout	0.0 (invalid) , 0.1s ~ 60.0s	0.0s

This parameter is invalid when set to 0.0s.

Function Code	Parameter Name	Setting Range	Default
F13.05	Modbus protocol selection	0: Non-standard Modbus protocol 1: Standard Modbus protocol	1

Function Code	Parameter Name	Setting Range	Default
F13.06	Communication reading current resolution	0: 0.01A 1: 0.1A	0

Group F15: Motor 2 Parameters

Drive can switch over two motor. This two motor can set independent nameplate parameters and self-learning.

Refer to description of motor 1 parameter

Chapter 7 Fault Diagnosis and Trouble Shooting

7.1 Faults and Solutions

The drive provides a total of 34 pieces of fault information and protective functions. After a fault occurs, the AC drive implements the protection function, and displays the fault code on the operation panel (if the operation panel is available).

Before contacting for technical support, you can first determine the fault type, analyze the causes, and perform troubleshooting according to the following tables. If the fault cannot be rectified, contact the agent or Folinn.

E033 is the AC drive hardware overcurrent or overvoltage signal. In most situations, hardware overvoltage fault causes E033.

Display	Fault Name	Possible Causes	Solutions
E001	Bus under-voltage	<ol style="list-style-type: none"> 1. instantaneous power failure 2. input voltage of the inverter is not within the specified requirements 3. bus voltage is abnormal 4. rectifier bridge and buffer resistance is abnormal 5. drive board is abnormal 6. main control board is abnormal 	<ol style="list-style-type: none"> 1. fault reset 2. adjust to normal voltage 3. seek technical support 4. seek technical support 5. seek technical support 6. seek technical support
E002	Over-voltage during acceleration	<ol style="list-style-type: none"> 1. input voltage is too high 2. external force dragging motor running in the process of acceleration 3. acceleration time is too short 4. have no install brake unit or brake resistance 	<ol style="list-style-type: none"> 1. adjust to normal voltage 2. cancel external force or add a brake resistance 3. increase acceleration time 4. install brake unit or brake resistance
E003	Over-voltage at constant speed running	<ol style="list-style-type: none"> 1. input voltage is too high 2. external force dragging motor running in the process of running 	<ol style="list-style-type: none"> 1. adjust to normal voltage 2. cancel external force or add a brake resistance

Display	Fault Name	Possible Causes	Solutions
E004	Over-current during acceleration	<ol style="list-style-type: none"> 1. AC drive output circuit is ground or short circuit 2. no self-learning of motor parameter 3. acceleration time is too short 4. manual torque boost or V/F curve is not suitable 5. voltage is too low 6. start rotating motor 7. additional load when acceleration 8. AC drive type is too small 	<ol style="list-style-type: none"> 1. eliminate external faults 2. self-learning of motor parameter 3. increase acceleration time 4. adjust manual torque boost or V/F curve 5. adjust to normal voltage 6. speed tracking restart or start after motor stop 7. cancel additional load 8. select an AC drive of higher power class
E005	Over-current during deceleration	<ol style="list-style-type: none"> 1. AC drive output circuit is ground or short circuit 2. no self-learning of motor parameter 3. deceleration time is too short 4. voltage is too low 5. additional load when deceleration 6. have no install brake unit or brake resistance 	<ol style="list-style-type: none"> 1. eliminate external faults 2. self-learning of motor parameter 3. increase deceleration time 4. adjust to normal voltage 5. cancel additional load 6. install brake unit or brake resistance
E006	Over-current at constant speed running	<ol style="list-style-type: none"> 1. AC drive output circuit is ground or short circuit 2. no self-learning of motor parameter 3. voltage is too low 4. additional load when running 5. AC drive type is too small 	<ol style="list-style-type: none"> 1. eliminate external faults 2. self-learning of motor parameter 3. adjust to normal voltage 4. cancel additional load 5. select an AC drive of higher power class.
E007	Motor overload	<ol style="list-style-type: none"> 1. Whether protection parameter F09.10 is suitable 2. Whether load is too heavy or motor lock-rotor 3. AC drive type is too small 	<ol style="list-style-type: none"> 1. setting parameter correctly 2. reduce the load and check the motor and mechanical condition. 3. select an AC drive of higher power class.

Display	Fault Name	Possible Causes	Solutions
E008	AC drive overload	1.The load is too heavy or locked motor occurs on the motor. 2.The AC drive model is of too small power class.	1. reduce the load and check the motor and mechanical condition. 2. select an AC drive of higher power class.
E00A	Overvoltage during deceleration	1: The input voltage is too high. 2: An external force drives the motor during acceleration. 3: The acceleration time is too short. 4: The braking unit and braking resistor are not installed.	1.adjust the voltage to normal range. 2.cancel the external force or install a braking resistor. 3.increase the acceleration time. 4.install the braking unit and braking resistor.
E00d	External equipment fault	1.external fault signal is input via S. 2.external fault signal is input via virtual I/O.	1.reset the operation 2.reset the operation
E00E	Module overheat	1.the ambient temperature is too high. 2. the air filter is blocked. 3.the fan is damaged. 4. the thermally sensitive resistor of the module is damaged. 5.the inverter module is damaged.	1.lower the ambient temperature. 2.clean the air filter. 3.replace the damaged fan. 4.replace the damaged thermally sensitive resistor. 5.replace the inverter module.
E00F	EEPROM readwrite fault	The EEPROM chip is damaged.	Replace the main control board.
E012	Power input phase loss	1.the three-phase power input is abnormal. 2.the drive board is faulty. 3.the lightning board is faulty. 4.the main control board is faulty.	1.eliminate external faults. 2.seek technical support 3.seek technical support 4.seek technical support
E013	Power output phase loss	1.the cable connecting the AC drive and the motor is faulty. 2.the AC drive's three-phase outputs are unbalanced when the motor is running. 3.the drive board is faulty. 4.the module is faulty.	1.eliminate external faults. 2.check whether the motor three-phase winding is normal. 3.seek technical support 4.seek technical support

Display	Fault Name	Possible Causes	Solutions
E015	Current detection fault	1.the HALL device is faulty. 2.the drive board is faulty.	1.replace the faulty HALL device. 2.replace the faulty drive board.
E016	Motor self-learning fault	1.the motor parameters are not set according to the nameplate. 2.the motor self-learning times out.	1.set the motor parameters according to the nameplate properly. 2.check the cable connecting the AC drive and the motor.
E017	Contacting fault	1.the drive board and power supply are faulty. 2.the contactor is faulty.	1.replace the faulty drive board or power supply board. 2.replace the faulty contactor.
E018	Communication fault	1.the host computer is in abnormal state. 2.the communication cable is faulty. 3: F00.02 is set improperly. 4.the communication parameters in group F13 are set improperly.	1.check the cabling of host computer. 2.check the communication cabling. 3.set F00.02 correctly. 4.set the communication parameters properly.
E020	Accumulative running time reached	The accumulative running time reaches the setting value.	Clear the record through the parameter initialization function.
E023	Short circuit to ground	The motor is short circuited to the ground.	Replace the cable or motor
E026	Encoder fault	1.the encoder type is incorrect. 2.the cable connection of the encoder is incorrect. 3.the encoder is damaged. 4.the PG card is faulty.	1.set the encoder type correctly based on the actual situation. 2.eliminate external faults. 3.replace the damaged encoder. 4.replace the faulty PG card.
E029	Accumulative power-on time reached	The accumulative power-on time reaches the setting value.	Clear the record through the parameter initialization function.
E02E	PID feedback lost during running	The PID feedback is lower than the setting of F10.26.	Check the PID feedback signal or set F10.26 to a proper value.
E030	Load becoming 0	The AC drive running current is lower than F09.13.	Check that the load is disconnected or the setting of F09.13 and F09.14 is correct.

Display	Fault Name	Possible Causes	Solutions
E032	Pulse-by-pulse current limit fault	1.the load is too heavy or locked motor occurs on the motor. 2.the AC drive model is too small power class.	1.reduce the load and check the motor and mechanical condition. 2.select an AC drive of higher power class.
E033	AC drive hardware fault	1.overvoltage exists. 2.overcurrent exists.	1.handle based on overvoltage. 2.handle based on overcurrent.
E034	Too large speed deviation	1.the encoder parameters are set incorrectly. 2.the motor self-learning is not performed. 3.F09.17 and F09.60 are set incorrectly.	1.set the encoder parameters properly. 2.perform the motor self-learning. 3.set F09.17 and F09.60 correctly based on the actual situation.
E035	Motor over-speed	1.the encoder parameters are set incorrectly. 2.the motor self-learning is not performed. 3.F09.17 and F09.60 are set incorrectly.	1.set the encoder parameters properly. 2.perform the motor self-learning. 3.set F09.17 and F09.60 correctly based on the actual situation.
E036	Motor overheat	1.the cabling of the temperature sensor becomes loose. 2.the motor temperature is too high.	1.check the temperature sensor cabling and eliminate the cabling fault. 2.lower the carrier frequency or adopt other heat radiation measures.
E037	Initial position fault	The motor parameters are not set based on the actual situation.	Check that the motor parameters are set correctly and whether the setting of rated current is too small.
E038	Motor switch over fault during running	Change the selection of the motor via terminal during running of the AC drive.	Perform motor switch over after the AC drive stops.

7.2 Common Faults and Solutions

You may come across the following faults during the use of the AC drive. Refer to the following table for simple fault analysis.

Table 7-1 Troubleshooting to common faults of the AC drive

SN	Fault	Possible Causes	Solutions
1	There is no display at power-on.	1.there is no power supply to the AC drive or the power input to the AC drive is too low. 2.the power supply of the switch on the drive board of the AC drive is faulty. 3.the rectifier bridge is damaged. 4.the control board or the operation panel is faulty. 5.the cable connecting the control board and the drive board and the operation panel breaks.	1. check the power supply. 2. check the bus voltage. 3. re-connect the 34-core cables. 4. seek technical support
2	“bd600” is displayed at power-on.	1.the cable between the drive board and the control board is in poor contact. 2.related components on the control board are damaged. 3.the motor or the motor cable is short circuited to the ground. 4.the HALL device is faulty. 5.the power input to the AC drive is too low.	1. re-connect the 34-core cables. 2. seek technical support
3	“E023” is displayed at power-on.	1.the motor or the motor output cable is short-circuited to the ground. 2.the AC drive is damaged.	1.measure the insulation of the motor and the output cable with a megger. 2.seek technical support
4	The AC drive display is normal upon poweron. But “bd600” is displayed after running and stops immediately.	1.the cooling fan is damaged or locked-rotor occurs. 2.the external control terminal cable is short circuited.	1.replace the damaged fan. 2.eliminate external fault.
5	E00E (module overheat) fault is reported frequently.	1.the setting of carrier frequency is too high. 2.the cooling fan is damaged, or the air filter is blocked. 3.components inside the AC drive are damaged (thermal coupler or others).	1.reduce the carrier frequency (F00.17). 2.seplace the fan and clean the air filter. 3.seek technical support
6	The motor does not rotate after the AC drive runs.	1.check the motor and the motor cables. 2.the AC drive parameters are set improperly (motor parameters). 3.the cable between the drive board and the control board is in poor contact. 4.the drive board is faulty.	1.ensure the cable between the AC drive and the motor is normal. 2.replace the motor or clear mechanical faults. 3.check and re-set motor parameters.

SN	Fault	Possible Causes	Solutions
7	The S terminals are disabled.	1.the parameters are set incorrectly. 2.the external signal is incorrect. 3.the jumper bar across DCM and +24 V becomes loose. 4.the control board is faulty.	1.check and reset the parameters in group F05. 2.re-connect the external signal cables. 3.re-confirm the jumper bar across DCM and +24 V. 4.seek technical support
8	The motor speed is always low in close loop vector control mode.	1.the encoder is faulty. 2.the encoder cable is connected incorrectly or in poor contact. 3.the PG card is faulty. 4.the drive board is faulty.	1.replace the encoder and ensure the cabling is proper. 2.replace the PG card. 3.seek technical support
9	The AC drive reports overcurrent and overvoltage frequently.	1.the motor parameters are set improperly. 2.the acceleration/deceleration time is improper. 3.the load fluctuates.	1.re-set motor parameters or re-perform the motor self-learning. 2.set proper acceleration/ deceleration time. 3.seek technical support
10	E017 is reported upon power-on or running.	The soft startup contactor is not picked up.	1.check whether the contactor cable is loose. 2.check whether the contactor is faulty. 3.heck whether 24 V power supply of the contactor is faulty. 4.seek technical support
11	88888 is displayed upon power-on.	Related component on the control board is damaged.	Replace the control board.

Appendix A Serial Communications

The AC drive provide the RS485 communication interface, and adopt the ModBus communication protocol of international standard to make master- slave communication. Users can realize centralized control by PC/ PLC, upper computer controlling and so on(set the controlling command, operation frequency, correlation function code parameters change, inverter working state and fault information monitoring, etc.), so as to adapt to specific application requirements.

1. Protocol content

The Modbus serial communication protocol defines the frame content and using form of asynchronous transmission in serial communication, including: host polling and broadcast frame, slave response frame format; frame content of host organization includes: slave address (or the broadcast address) , performing commands, data and error checking, etc. ; slave response is also using the same structure , content including: action confirmation, data returning and error checking, etc. if error happens when slave is receiving frame, or cannot achieve the requirements of the host, it will organize a fault frame as a response feedback to the host.

2. Application way

The AC drive access the controlling network of "single master multiple slave" with RS232/ RS485 bus.

3. Bus structure

(1) The interface way
RS485 hardware interface

(2) Transmission mode

Asynchronous serial and half- duplex transmission mode. At the same time only one between the host and the slave can send data and the other receives data. In the process of serial asynchronous communication, data is sending in the form of message, and frame by frame.

(3) Topological structure

Single master multiple slave system. Slave address set range from 1 ~ 247, 0 as the broadcast address, and each slave address in the network has uniqueness. This is the foundation of guaranteeing Modbus serial communication.

4. Protocol specification

The communication protocol of AC drive is a kind of master-slave Modbus communication protocol with asynchronous serial, and in the network only one device (host) can establish protocol (called "query/ command") . Other device (slave) can only respond to "query/ command" of the host with the provided data, or make corresponding action according to the "query/ command" of the host. Host here refers to the personal computer (PC) , industrial control equipment or programmable logic controller (PLC) , etc. , and slave refers to drive or other controlling equipment of the same communication protocol. Host can not only separately communicate with a certain slave, but also can release broadcast information to all slaves. For the separately "query/ command" of the host, slave should return a information (called response) , and for broadcast information of the host, the slave does not have to feedback information to the host.

5. Communication frame structure

The Modbus protocol communication data format of drives as following :
In RTU mode, new information always becomes silent for at least 3. 5 bytes of transmission time as a start. In the network that calculates transmission rate by baud rate, transmission time of 3. 5 bytes can be easily grasped. And then the transmitted data fields are, in order: slave address, operation command code, data and CRC check words,transmitted bytes of each domain are hexadecimal 0 . . . 9, A . . . F. network device always monitors the activities of the communication bus, even in the silent intervals. When receiving the first field (address information) , each network device will conform the byte. With the last byte transmission completion, a similar 3. 5 bytes of transmission time interval is used to show the end of the frame. After this, the transmission of a new frame will start.

Information of a frame must be transmitted in a continuous flow of data. If the interval is more than 1. 5 bytes before the end of the whole frame transmission, the receiving device will remove the incomplete information, and mistakenly consider the following byte to be part of a new frame address. In the same way, if the interval between the start of a new frame and previous frame is less than 3. 5 bytes, receiving device will consider it to be a continuation of the previous frame. Because of the frame disorder, the final CRC check value is not correct, which will lead to communication fault.

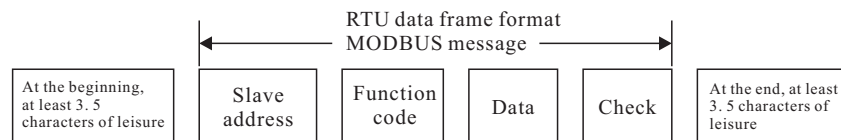

The standard structure of RTU frame:

START	T1-T2-T3-T4 (3. 5 bytes of transmission time)
SLAVE ADDR	Communication address: 1~247
CMD	03H : read slave parameters : 06H : write slave parameters
DATA (N-1)	Data: function code parameter address, number of function code parameter ,value of function code parameter
DATA (N-2)	
... ..	
DATA0	
CRC CHK high- order	Check value: CRC
CRC CHK low- order	
END	T1-T2-T3-T4 (3. 5 bytes of transmission time)

Command code (CMD): 03H , read N words (at most continuously read 12 words) . For example, the inverter of which slave address is 01, memory starting address is F02, when continuously reading two words, and then the host command information as below:

ADR	01H
CMD	03H
Starting address high- order	F0H
Starting address low- order	02H
Number of data high- order	00H
Number of data low- order	02H
CRC CHK low- order	need to calculate CRC,CHK
CRC CHK high- order	

Slave response information

When F13.05 set to 0:

ADR	01H
CMD	03H
Number of bytes high-order	00H
Number of bytes low-order	04H
Data address F002H high- order	00H
Data address F002H low- order	00H
Data address F003H high- order	00H
Data address F003H low- order	01H
CRC CHK low- order	need to calculate CRC,CHK
CRC CHK high- order	

When F13.05 set to 1:

ADR	01H
CMD	03H
Number of bytes	04H
Data address F002H high- order	00H
Data address F002H low- order	00H
Data address F003H high- order	00H
Data address F003H low- order	01H
CRC CHK low-order	need to calculate CRC,CHK
CRC CHK high-order	

Command code: 06H, write a word

For example, write 5000(1388H) in F00AH address of inverter that the slave address is 02H.

Host command information

ADR	02H
CMD	06H
Data address high-order	F0H
Data address low-order	0AH
Data content high- order	13H
Data content low- order	88H
CRC CHK low- order	need to calculate CRC,CHK
CRC CHK high- order	

Slave response information

ADR	02H
CMD	06H
Data address high-order	F0H
Data address low-order	0AH
Data content high- order	13H
Data content low- order	88H
CRC CHK low- order	need to calculate CRC,CHK
CRC CHK high- order	

CRC checking methods- - CRC(Cyclical Redundancy Check) :

Use the RTU frame format, and frame contains frame error detection domain based on CRC calculation. CRC domain detects the content of the entire frame. CRC domain is two bytes, containing 16 bit binary value. It joins the frame after calculated by the transmission equipment, and the receiving device recalculates CRC of the received frame, and compared with the received value of CRC domain, if the two CRC value is not equal, then there is an error in transmission.

CRC is deposited in the OxFFFF first, and then process more than six consecutive bytes of the frame with the value of current register. Only 8 bit data of each character is valid for CRC, and the start bit and stop bit and parity bit are all invalid.

In the process of CRC, each 8- bit character is separately XOR with register content, and as a result, moves to the lowest effective direction, and the highest effective bit fills with 0. LSB is extracted to detect, if the LSB is 1, register is separately XOR with preset value, if the LSB is 0, then give up. The whole process will repeat 8 times. After the completion of the final bit (eighth bit) , next 8- bit bytes will separately XOR with the current value of register. The value in the register finally is the CRC value after all bytes in the frame perform.

This calculation method of CRC adopts the CRC check rule of international standards. When users edit CRC algorithm, they can refer to relevant standard of the CRC algorithm, and write CRC calculation program that really meets the requirements.

Now offer a simple function of CRC calculation for user reference (programming with C language) :

```

unsigned int crc_chk_value (unsigned char *data_value, unsigned char length)
{
    unsigned int crc_value=0xFFFF;
    int i;
    while (length-->0)
    {
        crc_value^=*data_value++;
        for (i=0; i<8; i++)
        {
            if(crc_value&0x0001)
            {
                crc_value= (crc_value>>1) ^ 0xa001;
            }
            else
            {
                crc_value=crc_value>>1;
            }
        }
    }
    return (crc_value) ;
}
    
```

The definition of communication data address:

This part is the address definition of communication data, and used to control the operation of the inverter, obtain inverter state information and related function parameters settings, etc.

6. Function code parameter address rules

High and low byte range respectively: high byte F0~FE(F group),A0~A2(F15~F17 group) ; low byte 00~FF. For example, if visit F04.02, so the function code address is 0xF40C.

Note: F14 group: manufactures setting parameters, neither can read this group of parameter, nor change this group of parameters; F17 group: can read this group of parameter, but can not change parameter. When inverter is in operation, some parameters cannot be changed; some parameters cannot be changed no matter what state the inverter is; when changing the function code parameters, you also should note the parameter setting range, units, and related instructions.

Function code group	Communication visit address	Function code address of communication change RAM
F00~F14	0xF000~0xFEFF	0x0000~0x0EFF
F15~F17	0xA000~0xA2FF	0x4000~0x42FF

Because the EEPROM is frequently stored, it will reduce the service life of EEPROM. As for users, some function code does not need to be stored under the mode of communication, and only need to change the value of RAM to satisfy the usage requirements. This function can be achieved only by changing the high-order of the corresponding code address from F to 0.

High and low byte range respectively: high byte 00~0F(F group); low byte 00~FF.

For example:

Function code F04.12 is not stored in the EEPROM, and set the address to 040C.

Function code F15.51 is not stored in the EEPROM, and set the address to 4033.

This address can only be used for chip RAM, and cannot used as a function of reading, if doing so, then invalid address. For all parameter, it can realize this function by command code 07H.

Control command input to AC drive: (only write)

Command address	Command function
1000H	0001H : forward running
	0002H : reverse running
	0003H : forward jog
	0004H : reverse jog
	0005H : free stop
	0006H : decelerate to stop
0007H : fault resetting	

Digital output to terminal control: (only write)

Command address	Command function
1001H	BIT0: MO1 output control
	BIT1: retain
	BIT2: RA output control
	BIT3: TA output control
	BIT4: HDO output control
	BIT5: retain
	BIT6: retain
	BIT7: retain
	BIT8: retain
	BIT9: retain

Analog output AO1 control: (only write)

Command address	Command function
1002H	0~7FFF means 0%~100%

Analog output AO2 control: (only write)

Command address	Command function
1003H	0~7FFF means 0%~100%

Pulse output control: (only write)

Command address	Command function
1004H	0~7FFF means 0%~100%

Read AC drive status: (only write)

Status address	Status function
2000H	0001: forward running
	0002: reverse running
	0003: stop

Stop/run parameter address:

Address	Data meaning
3000H	*communication setting range (-10000~10000) (decimalism)
3001H	frequency running
3002H	bus voltage
3003H	output voltage
3004H	output current
3005H	output power
3006H	output torque
3007H	run speed
3008H	terminal input symbol
3009H	terminal output symbol
300AH	AI1 voltage
300BH	AI2 voltage
300CH	AI3 voltage
300DH	count value input
300EH	length valuse input
300FH	load speed
3010H	PID setting

Address	Data meaning
3011H	PID feedback value
3012H	PLC steps
3013H	input pulse frequency, unit is 0.01kHz
3014H	feedback speed, unit is 0.1Hz
3015H	residue running time
3016H	AI1 voltage before correcting
3017H	AI2 voltage before correcting
3018H	AI3 voltage before correcting
3019H	line speed
301AH	current power on time
301BH	current run time
301CH	input pulse frequency, unit is 1Hz
301DH	communication setting time
301EH	actual feedback speed
301FH	A frequency display
3020H	B frequency display

Note: communication setting value is relative percentage (-100.00%~100.00%), and can make communication write operations. When setting as frequency source, relative is the largest frequency(F00.03); When setting as torque source, relative is F03.10, F15.48 (motor1, motor2.)

Parameter lock password calibration: (if back to 8888H, is means password calibration passed)

Address	Data meaning
1F00H	*****

Parameter initializing address is 1F01H:

Parameter initializing address	Command function
1F01H	0001H: factory reset, not include motor parameter
	0002H: clear fault file

AC Drive fault description:

AC Drive fault address	AC Drive fault information
8000H	0000H: no fault
	0001H: acceleration overcurrent (E004)
	0002H: deceleration overcurrent (E005)
	0003H: constant speed overcurrent (E006)
	0004H: acceleration overvoltage (E002)
	0005H: deceleration overvoltage (E00A)
	0006H: constant speed overvoltage (E003)
	0007H: undervoltage fault (E001)
	0008H: motor overload (E007)
	0009H: AC drive overload (E008)
	000AH: input phase loss (E012)
	000BH: output phase loss (E013)
	000CH: module overheat (E00E)
	000DH: buffer resistance overload (E014)
	000EH: contactor fault (E017)
	000FH: external fault (E00d)
	0010H: communication fault (E018)
	0011H: current detection fault (E015)
	0012H: motor self-learning fault (E016)
	0013H: accumulative running time reached (E020)
	0014H: EEPROM readwrite fault (E00F)
	0015H: Short circuit to ground (E023)
	0016H: PID feedback lost during running (E02E)
	0017H: encoder fault (E026)
	0018H: AC drive hardware fault (E033)
	0019H: accumulative power-on time reached (E029)
	001AH: load becoming 0 (E030)
	001BH: rapid current limit timeout (E032)
	001CH: too large speed deviation (E034)
	001DH: motor switch over fault during running (E038)
001EH: motor over-speed (E035)	

AC Drive fault address	AC Drive fault information
8000H	001FH: motor overheat (E036)
	0020H: initial position fault (E037)

Communication fault description: (fault code)

Communication fault address	Communication fault information
8001H	0000H: no fault
	0001H: wrong password
	0002H: wrong command code
	0003H: wrong CRC check
	0004H: invalid address
	0005H: invalid parameter
	0006H: invalid parameter change
	0007H: system is locked
	0008H: inverter busy (EEPROM in storage)

Appendix B External Dimension

1.External dimension 1: wall-mounted housing

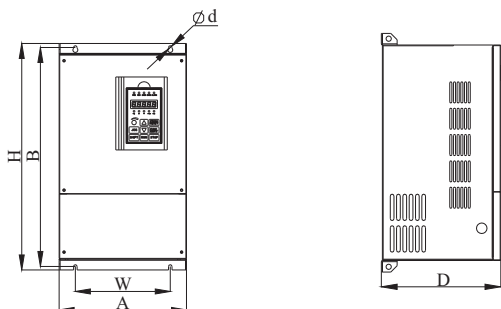

2.External dimension 2: wall-mounted/ floor combination housing

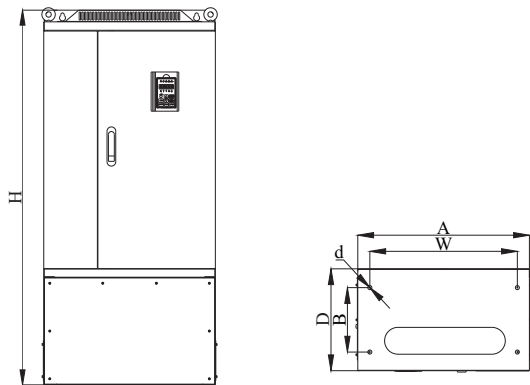

Base No.	Power (kW)	Dimensions (mm)						Housing
		A-width	H-height	D-depth	W	B	d	
B10	0.55kW	116	175	153	103	165	5	Wall-mounted plastic housing
	0.75kW							
	1.5kW							
B01	2.2kW	134	251	173	121	238	5	
	3.7kW							
B02	5.5kW	161	274	198	148	261	6	
	7.5kW							

Base No.	Power (kW)	Dimensions (mm)						Housing
		A-width	H-height	D-depth	W	B	d	
B10	0.75kW	116	175	153	103	165	5	Wall-mounted plastic housing
	1.5kW							
	2.2kW							
B01	3.7kW	134	251	173	121	238	5	
B02	5.5kW	161	274	198	148	261	6	
	7.5kW							
B03	11kW	210	343	215	195	327	6	
	15kW							
B11	18.5kW	220	395	222	160	378	7	
B04	22kW	255	453	237	190	440	8	
	30kW							
B05	37kW	280	582	295	200	563	9	
	45kW							
B06	55kW	300	685	327	200	667	11	
	75kW							
B07	93kW	420	840	334	150*150	815	11	
	110kW							
	132kW							
	160kW							
B09	187kW	640	1035	390	250*250	1003	11	
	200kW							
	220kW							
	250kW							
	280kW							
B12	315kW	950	1300	415	350*350	1262	15	
	350kW							
	400kW							
B07-G	450kW	420	1108	334	320	230	12	
	110kW							
B09-G	132kW	640	1400	390	550	240	15	Floor type steel casing housing
	160kW							
	200kW							
	220kW							
B12-G	250kW	950	1652	415	825	245	15	
	280kW							
	315kW							
B12-G	350kW	950	1652	415	825	245	15	
	400kW							
	450kW							

Appendix C Accessories Selection

1: Brake unit and brake resistance

Voltage	AC drive Power	brake unit		brake resistance		brake torque (10%UD)	
		model	quantity (piece)	power(W) /resistance value(Ω)	quantity (piece)		
220V	0.55kW	Built-in		80	120	1	
	0.75kW			80	120	1	
	1.5kW			150	100	1	
	2.2kW			300	68	1	
	3.7kW			300	68	1	
	5.5kW			400	30	1	
	7.5kW			400	30	1	
380V	0.75kW				150	300	1
	1.5kW				200	300	1
	2.2kW				200	200	1
	3.7kW				400	150	1
	5.5kW				400	100	1
	7.5kW				750	75	1
	11kW				1000	60	1
	15kW			1500	40	1	
	18.5kW			2500	30	1	
	22kW			3000	30	1	
	30kW	DBU-4030	1	5000	25	1	
	37kW	DBU-4045	1	7500	20	1	
	45kW		1	10000	13.6	1	
	55kW	DBU-4030	2	5000*2	25	1	
	75kW	DBU-4045	2	7500*2	15	1	
	93kW		2	10000*2	13.6	1	
	110kW	DBU-4160	1	20000	8	1	
	132kW		1	25000	6	1	
	160kW		1	30000	6	1	
	200kW		1	35000	4.5	1	
	220kW	DBU-4280	1	40000	4.5	1	
250kW	1		45000	4	1		
280kW	1		50000	3.5	1		
315kW	1		55000	3	1		
350kW	1		60000	2.5	1		
400kW	1		60000	2.5	1		
500kW	1		80000	2	1		

Notes :

1: Please select the power and the resistance value recommended by our company.
 2: The power and the resistance value that recommended above can be calculated by 100% braking torque and 10% frequency of utilization. The power and the resistance value can be appropriately reduced as long as it meets the load demand and the system is reliable: The power and the resistance value of the braking resistor should be appropriately changed if the braking torque and frequency of utilization need to be increased, or users can contact the company.

3: When installing a braking resistor, please consider the safety and the inflammability of the surrounding environment.

4: The frequency of use of Braking $UD=t1/t2*100\%$

$t1$: the braking time in a working period

$t2$: a working period

If the braking efficiency is double, the power of the corresponding braking unit and braking resistor also need to be double.

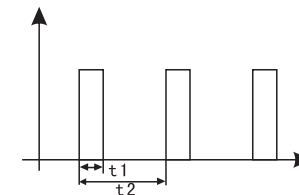

5. The resistance of the resistor that over 2500W and the power are the total amount of resistance and power. The power of the resistor is get from parallel connection based on 2500W. For example, to get a 25000W 6Ω IS, ten 2500W 60Ω resistors are needed to be connected in parallel.

The calculation of braking resistor: Statistics show that

$$IB=IMN/2 \rightarrow TB \approx TMN \text{ or } IB=2UB/IMN$$

Notes : IB—braking current , A ; IMN—the motor rated current , A ;

TB—braking torque, N·m ; TMN—rated load torque of motor, N·m.

As a general rule, the range of choice of braking torque is :

$$TMN < TB < 2TMN \quad IMN < IB < 2IMN$$

According to specific situation, users can decide the braking current according to the formula (3-12) and (3-13).

After that, it is easy to calculate the braking resistance :

$$RB=UB/IB \quad RBmin=UB/IMN$$

Notes : UB is the braking threshold voltage ; RB is braking resistor value . UB is 1.1 times as that of the rated voltage of bus. RBmin is the minimum braking resistance the common braking threshold voltage :

$$AC220V : DC380V \quad AC380V : DC680V \quad AC660V : DC1140V$$

When get IB and RB, the power of resistance will be known.

λ : Actual resistance value/calculated value ED%: Braking efficiency e. g:

Suppose that there is a 7.5kW motor, rated current is 18A and rated input voltage is 380V

$$\text{and : } RB=680V/9A=75\Omega$$

$$RBmin=680/18=38\Omega$$

Empirically, the value is 75Ω

$$\text{The power of braking resistor} = 1*680^2 / 75*0.1 = 616W$$

The power can be appropriately enlarged in actual use.

2. Mounting dimension of brake resistance

rated power	dimension (mm)									
(w)	L1 (±2)	L2 (±5)	L3 (±3)	D (±2)	B	B1	H	H1 (±3)	N	∅d
80	152	174	196	28	6.5	28	28	61	10	4.5
150	195	217	239	40	8	40	41	81	12	5.5
200	195	217	239	40	8	40	41	81	12	5.5
300	282	304	326	40	8	40	41	81	12	5.5
400	282	304	326	40	8	40	41	81	12	5.5
750	316	338	360	50	8	50	45	101	16	6
1000	300	325	350	60	8.5	60	60	119	16	6
1500	415	440	465	60	8.5	60	60	119	16	6
2000	510	535	560	60	8.5	60	60	119	16	6
2500	600	625	650	60	8.5	60	60	119	16	6

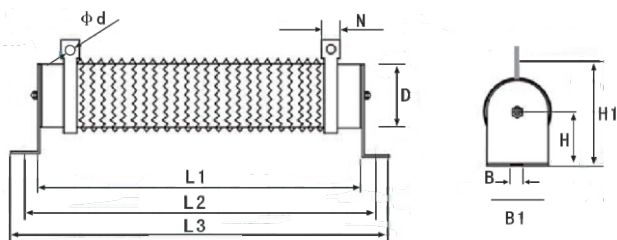

3. Display panel



Hole diameter of the panel installation box (height*width) : 142*98mm
size of outline box : 147*103

Appendix D Using Introduction of I/O extension card

1. Introduction

BD-IO02 is I/O extension card of AC (applied to all models).BD-IO03 extends 4 multi-function digital input (it can be extends HDI high speed pulse input), 1 HDO output terminal (it can be extends HDI high speed pulse output or open collector output)

2. Installation and description

1) Installation:

- ①: make sure the AC drive is power off completely.
- ②: aim I/O extension card to interface and install.
- ③: fix by screw

2)Description:

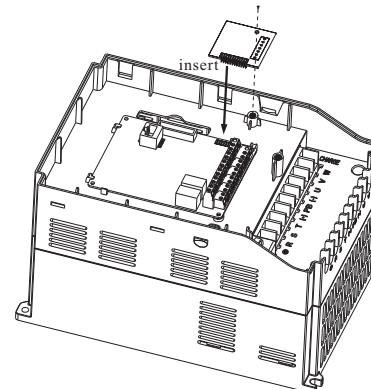

Figure 1 Install of I/O extension card

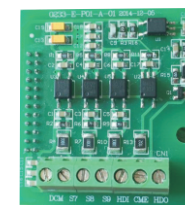

Figure 2 Extension card

DCM	S7	S8	S9	HDI	CME	HDO
-----	----	----	----	-----	-----	-----

Figure 3 Wiring terminal of extension card

② Description of I/O extension card control circuit terminal :

Terminal identification	Terminal function description	
S7-DCM	Multifunctional input terminal 7	Function setting: F05.06~F05.09
S8-DCM	Multifunctional input terminal 8	
S9-DCM	Multifunctional input terminal 9	
HDI-DCM	High speed pulse input terminal Max.input frequency 100kHz	Function setting : F06.00 Function setting : F06.01/F06.12, F06.07/F06.21、F06.22
HDO-CME	Multifunctional output terminal (it can be high-speed pulse output terminal or open collector output)	

Appendix E Using Introduction of PG card

1. Introduction

BD-PG03 is PG card of AC (applied to all models) as optional accessories when close-loop vector control.

2.Installation and description

1) Installation:

- ①: make sure the AC drive is power off completely.
- ②: insert PG card and extension card of inverter.
- ③: fix by screw as Figure 1

2) The appearance, terminal block and function description are shown in figure 1, figure 2 and table 1.

① diagram of PG card

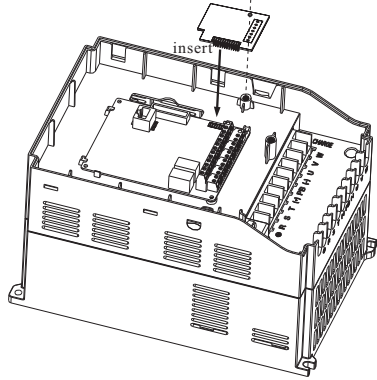

Figure 1 Install of PG extension card

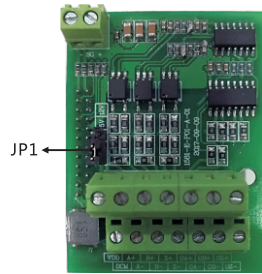

Figure 2 PG card

VDD	A+	B+	Z+	OA+	OB+	OZ+
DCM	A-	B-	Z-	OA-	OB-	OZ-

Figure 3 Wiring terminal of PG card

② Description of PG card terminal :

Terminal identification	Terminal function description
A+	encoder output A signal positive
A-	encoder output A signal negative
B+	encoder output B signal positive
B-	encoder output B signal negative
Z+	encoder output Z signal positive
Z-	encoder output Z signal negative
VDD	encoder input power supply
DCM	power supply pool

OA+	frequency dividing output A signal positive
OA-	frequency dividing output A signal negative
OB+	frequency dividing output B signal positive
OB-	frequency dividing output B signal negative
OZ+	frequency dividing output Z signal positive
OZ-	frequency dividing output Z signal negative

3、 PG card jumper function:

JP1: encoder input power supply+5V/12V switch over



Warranty Card

Name of unit:	
Add. of unit:	
P.C.:	Contact person:
Tel.:	Fax.:
Product model:	
Power:	
Contract No.	Purchased Date
Name of agent:	
Maintenance time and content	
Maintenance personnel:	